

astro
LED Lighting

2024

GLOSARIO DE ACABADOS Y NOMENCLATURAS



TEMPERATURA DE COLOR (CT)



CT Temperatura de Color

WW Luz Cálida: (Entre 2700K y 3500K). Crea un ambiente íntimo y/o acogedor.

Es recomendable en tiendas de ropa, fruterías, panaderías y carnicerías. En viviendas se recomienda su instalación en sala, comedor y dormitorios.

NW Luz Neutra: (Entre 3800K y 4500K). Es la luz "más natural". Se puede instalar en cualquier entorno que no requiera del matiz específico que puedan aportar las otras 2 categorías.

DW Luz de Día: (5000K). Equivale a la luz de un día nublado.

CW Luz Fría: (6000K). Equivale a la luz de un día muy soleado. Genera una percepción de mayor luminosidad. Recomendada para oficinas, pescaderías y joyerías. En viviendas, es habitual encontrarlo en cocinas y baños.

CCT: (Temperatura de Color Correlacionada). Define la apariencia de color de un LED blanco. Se define en grados Kelvin. Las luminarias con esta característica permiten ir cambiando de tonos de color.

RGB: (Rojo, Verde, Azul). Las luminarias con LED RGB combinan estos tres colores para producir aprox. 16 millones de tonos de luz.

NIVEL DE PROTECCIÓN

- IP 20** Protección sólo para polvo en instalación interior.
- IP 44** Protección contra objetos sólidos mayores de 1mm y contra proyecciones de agua en todas direcciones.
- IP 54** Protección contra el polvo y contra proyecciones de agua en todas direcciones.
- IP 55** Protección contra el polvo y contra chorros de agua en todas direcciones.
- IP 65** Protección contra el polvo y contra fuertes chorros de agua en todas direcciones.
- IP 66** Protección contra el polvo y contra las pulverizaciones de agua con una presión de 1 bar a 3m.
- IP 67** Protección completa del polvo y contra los efectos de la inmersión. Es necesario que debajo del housing se haga un dren para desalojar 10 litros de agua en 5 minutos.
- IP 68** Protección completa del polvo y contra los efectos de la inmersión prolongada en agua profunda.

ACABADOS

- 01 Blanco
- 02 Satinado
- 03 Gris
- 04 Grafito
- 05 Bronce Rust
- 06 Cromo
- 07 Negro
- 08 Acero
- 09 ABZ
- 10 Yeso
- 11 Concreto
- 12 Aluminio

Nuestras luminarias cuentan con algunas de las mejores marcas de LED en el mercado:



*Nota: El color de la fotografía puede variar de acuerdo a la original debido a limitaciones inherentes al proceso fotográfico.

ÍNDICE REFERENCIAL

01-10	FOCOS LED
11-27	DOWNLIGHTSBASIC
28-32	GYPSUM
33-42	DOWNLIGHTS
43-64	PROFESIONAL
65-72	CORTESÍA
73-89	OUTDOOR PARED
90-99	OUTDOOR PISO
100-105	SPIKE LIGHTS
106-110	SUBACUÁTICAS
111-116	BALIZAS
117-122	REFLECTORES
123-129	SISTEMAS RGB
130-133	INDUSTRIAL
134-135	URBANA
136-143	SOLARES
144-154	TIRAS LED
155-160	ACCESORIOS
161-170	CONTROL

ÍNDICE NUMÉRICO

00-1218-*	10	05-7491-*	75	06-3211-*	14	07-6401-*	97
00-2902-*	10	05-7492-*	75	06-3212-*	14	07-6401-RGB	125
00-2918-41	10	05-7493-*	74	06-3213-*	14	07-7053-*	91
00-2922-*	10	05-7494-*	74	06-3254-*	17	07-7301-*	97
01-30605	137	05-7510-*	86	06-3901-*	24	07-9201-*	91
03-2012-*	138	05-8054-*	75	06-3902-*	24	08-1273-*	67
03-4801-*	102	05-8107-*	82	06-3903-*	24	08-1901-*	72
03-4901-*	102	05-8108-*	82	06-4401-*	19	08-2201-*	72
03-9003-WW	103	05-8238-	88	06-4402-*	19	08-2203-*	72
03-9005-GU	103	05-9001-*	68	06-6313-*	35	08-3013-10	31
03-9101-E2	103	05-9006-E2-*	79	06-7010-*	36	08-7401-*	67
04-1202-WW	2	05-9105-*	101	06-7091-*	36	08-7501-*	67
04-1215-WW	2	05-9106-*	102	06-7092-*	36	08-8301-*	70
05-0010-*	119	05-9205-*	106	06-7095-*	36	08-8401-*	70
05-0020-*	119	05-9801-*	101	06-9033-10	34	08-8501-*	70
05-0030-*	119	06-0113-*	39	06-9034-*	34	08-9002-*	68
05-0050-*	120	06-0114-*	39	06-9035-*	34	08-9245-*	69
05-0093-*	84	06-0305-*	42	06-9129-10	30	10-1071-*	113
05-0094-*	84	06-0321-*	12	06-9130-10	30	10-1932-*	112
05-0502-RGB	127	06-0322-*	12	06-9131-10	30	10-2091-WW	114
05-0901-RGB	124	06-0323-*	12	06-9224-10	31	10-2103-	116
05-1018-*	80	06-0325-*	12	06-9229-10	30	10-2122-*	105
05-1241-	89	06-0329-*	13	06-9442-10	31	10-2351-*	104
05-1248-	89	06-0353-*	15	06-9703-10	32	10-2352-*	104
05-2016-	137	06-0357-*	15	06-9703-D	32	10-2522-*	116
05-2061-	86	06-0361-*	15	06-9703-I	32	10-2704-	113
05-2071-*	80	06-0370-*	15	06-9703-TD	32	10-2942-*	105
05-2072-*	80	06-0409-*	42	06-9703-TI	32	10-3341-	138
05-2091-*	76	06-0512-*	42	07-0061-*	95	11-1735-*	46
05-2101-*	81	06-0718-*	42	07-0062-*	95	11-2409-*	44
05-2102-*	81	06-1070-*	37	07-0301-*	92	11-2815-*	47
05-2121-*	85	06-1090-*	37	07-0301-RGB	124	11-2825-*	47
05-2143-	76	06-1224-*	42	07-0455-*	109	11-3001-*	45
05-2271-*	83	06-2011-*	62	07-07300-*	99	11-3202-*	16
05-2509-*	81	06-2012-*	35	07-07601-*	99	11-5009-*	45
05-2616-	83	06-2283-*	18	07-1011-	93	12-2815-*	47
05-2678-	87	06-2314-WW	35	07-1012-	93	12-2825-*	47
05-2701-*	82	06-2315-WW	35	07-1014-	93	15-0050-65	135
05-2799-*	66	06-2489-*	18	07-1015-08	92	15-0100-65	135
05-2800-*	66	06-2901-*	22	07-1276-*	67	15-0150-65	135
05-2801-*	66	06-2904-*	22	07-1280-*	71	20-1150-3TC	131
05-2805-*	66	06-2905-*	22	07-1701-*	91	20-3110-50	132
05-2806-*	66	06-2906-*	22	07-1701-RGB	124	20-7100-50	132
05-2807-*	66	06-2907-*	23	07-1703-*	91	20-9080-40	132
05-2921-*	76	06-2910-*	23	07-1707-*	108	20-9080-65	132
05-2942-*	87	06-2911-*	23	07-2702-*	71	22-0128-NW	40
05-3223-*	83	06-3106-*	20	07-2721-*	95	22-0210-*	133
05-3500-DW	121	06-3108-*	41	07-30011-*	98	22-0218-*	133
05-3505-CW	101	06-3110-*	41	07-30012-*	98	22-1130	55
05-5031-*	78	06-3117-*	41	07-30016-*	98	22-1216-*	63
05-5032-*	78	06-3123-*	21	07-30100-*	92	22-1232-*	63
05-6216-	88	06-3124-*	21	07-40921-*	94	22-2060-WW	62
05-6410-	87	06-3155-*	17	07-40922-*	94	22-2073-*	80
05-7001-*	71	06-3198-*	17	07-40926-*	94	22-2409-*	44
05-7021-*	109	06-3199-*	17	07-4201-*	71	22-2815-*	48
05-7021-RGB	126	06-3206-*	20	07-6201-*	96	22-2825-*	48
05-7131-*	79	06-3207-*	20	07-62024-*	108	22-3002-*	46
05-7132-*	79	06-3208-*	20	07-6301-*	96	22-3204-*	16
05-7302-*	77	06-3210-*	13	07-6301-RGB	125	22-5031-*	78

ÍNDICE NUMÉRICO

22-6136-DW	62	5-36100-RGB.....	128	C-003T	57	PS-24100	156
22-6503-*	44	5-36150-RGB.....	128	C-004C	57	PS-24100-D	158
22-6504-*	44	5-3620-RGB.....	128	C-005P	57	PS-24150	157
22-7133-*	79	5-3650-RGB.....	128	CON-221232.....	63	PS-24150-D	158
22-7161-*	74	55-1933-*	112	CON-B2-*	52	PS-24250	157
22-8401-*	9	55-2091-WW.....	114	CON-F6-*	52	PS-24400	157
22-8402-*	9	55-2704-*	113	CONL-221232-*.....	63	REP-3040-5A.....	166
22-8403-*	9	55-2773-*	115	CON-L3-*	52	REP-3060	166
22-8404-*	9	55-2775-*	115	CONT-221232-*.....	63	REP-3063	166
22-9036-*	34	55-4021-RGBW.....	129	CON-T4-*	52	REP-3070	166
22-9051-*	75	55-9107-*	113	CON-X5-*	52	TR-0310-*.....	49
23-1300-07	53	60-1007-*	5	DIM-D1	169	TR-0320-*.....	49
23-1300-14	53	60-1011-*	5	EBOX-AP	165	TRA-12100	160
23-2123-*	85	6-12554-*	27	EBOX-TD	165	TRA-12200	160
23-2815-*	48	6-12654-*	27	EX1S	164	TRA-1245	159
23-2825-*	48	6-21701-*	40	EX2	164	TRA-1250	159
25-6215-07.....	143	6-26752-RGB.....	124	EX4S	164	TRA-24100	160
25-6240-07.....	143	6-26951-*	37	EX5	164	TRA-24200	160
26-1340-*	64	6-26957-NW.....	37	EX6	164	TRA-2430	159
26-6640-*	64	6-29007-*	25	EX8S	164	TRA-2460	159
26-6640-CCT	64	6-29012-*	25	EXC1	164	TRK-1000-*	51
26-6675-50	64	64-2706-WW.....	6	EXC2	164	TRK-2000-*	51
27-4001-40	133	6-51112-*	26	EXC3	164	WiFi-106	165
30-0007-*	60	6-52112-*	26	EXC4	164	XR-0362-*.....	50
30-0010-*	60	6-53112-*	26	F4-5A	163	XR-0364LL-*.....	50
30-0012-*	60	66-3407-*	18	F4-CC	163	XR-0364LR-*.....	50
30-0024-*	58	77-0306-DW.....	110	FB-43282-*.....	145	XR-0364RL-*	50
30-0048-*	58	77-0391-*	110	FB-43528-*.....	145	XR-0364RR-*	50
30-0054-*	59	77-0393-RGB.....	126	FB-72282-*.....	146	XR-0365-*.....	50
30-0055-*	59	77-2501-*	107	FC-43286-*.....	151	XR-0366-*.....	50
30-0300-*	58	77-2503-*	107	FE-43287-*.....	147	XR-0367-*.....	50
30-0412-WW	7	77-2506-*	107	FE-72287-*.....	147	XR-361L-*.....	50
30-0500-*	61	77-4703-*	108	FS-0036-RGB.....	150	XR-361R-*.....	50
30-0510-*	60	77-4703-RGB	126	FS-1036-RGB.....	151	XR-363L-*.....	50
30-0600-*	58	77-6013-RGB	125	FS-27140	154	XR-363R-*.....	50
30-0811-*	59	77-6015-RGB	125	FS-27352-*.....	152	XR-369L-*.....	50
30-1000-*	61	80-0903-*	2	FS-43285-*.....	148	XR-369R-*.....	50
30-2307-*	59	80-0924-*	2	FS-48356-TC.....	149		
30-2308-*	59	80-1015-WW.....	8	FS-96555-RGBW.....	150		
35-1005-*	4	80-1112-*	8	FV-48110-*.....	152		
35-2703-WW.....	4	80-1205-*	3	HD05R	131		
40-2015-*	140	80-1603-RGB.....	3	HD06VCRH 7B.....	131		
40-2104-*	139	80-2003-*	7	K1	167		
40-2115-*	139	80-2007-*	3	K2	167		
40-2303-*	140	80-2225-*	3	M1+RGB-33A.....	168		
40-2306-*	140	80-3002-*	8	M2+RGB-33A.....	168		
40-2608-*	141	81-0925-WW.....	2	M3-3A	168		
45-1004-*	5	90-2501-RGB.....	127	M6+RGB-33A.....	168		
45-1204-WW	4	90-3001-*	118	M8+M4-5A.....	168		
45-2604-WW	6	90-3001-RGB.....	127	M-TRA100	57		
45-2704-WW	6	90-3201-WW.....	118	M-TRA200	57		
5-21101-NW	122	90-3202-*	118	PS-12025	156		
5-21101-RGB.....	129	97-06300-*.....	99	PS-12050	156		
5-21201-RGB.....	129	97-06601-*.....	99	PS-12100	164		
5-21301-NW	122	AP-1616	153	PS-12100-D.....	158		
52-4020	142	AP-2507	153	PS-12150	157		
5-25100-*	120	AP-2811	153	PS-12150-D.....	158		
5-25250-DW	121	C-001	57	PS-12250	157		
5-25400-WW.....	120	C-002L	57	PS-24050	156		



astro

LED Lighting

www.astroled.com.mx



FOCOS LED



G4 | G9

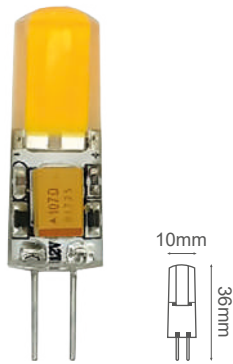

04-1202-WW



04-1215-WW



80-0924-*



81-0925-WW



80-0903-*

Modelo	Base	Watts	CT	Lúmenes	LED	Apertura	Voltaje	CRI	IP	Material
04-1202-WW	G4	1.5W	3000K	180	COB	360°	12V AC/DC	>80	20	Tapa de Gel
04-1215-WW	G4	1W	3000K	120	SMD	360°	12V AC/DC	>80	20	Cristal
80-0924-*	G9	3.5W	3000K / 4000K	380	SMD	350°	90-130V AC	>80	20	Cerámica + PC
81-0925-WW	G9	4W	3000K	500	SMD	350°	90-130V AC	>80	20	Cerámica + PC
80-0903-*	G9	4W	3000K / 4000K	360	SMD	90°	90-130V AC	>80	20	Cerámica + PC

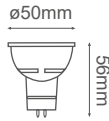

80-1205-*

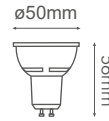

80-2007-* 

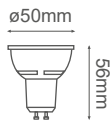

80-2225-*

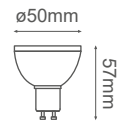

80-1603-RGB



*Incluido

GU5.3 | GU10

Modelo	Base	Bulbo	Watts	CT	Lúmenes	LED	Apertura	Voltaje	CRI	IP	Material
80-1205-*	GU5.3	MR16	5W	3000K / 4500K	400	SMD	38°	90-130V	>80	20	PC
80-2007-*	GU10	MR16	6.5W	3000K / 4000K	560	SMD	38°	90-130V	>80	20	PC 
80-2225-*	GU10	MR16	5W	2700K / 3000K / 4000K / 6500K	400	SMD	38°	100-240V	>80	20	PC
80-1603-RGB	GU10	MR16	3W	RGB	40	COB	35°	100-120V	-	20	Aluminio

E12

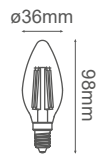

35-2703-WW

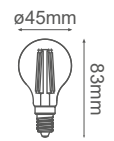

45-1204-WW

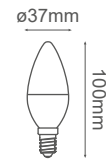

35-1005-*

Modelo	Base	Watts	CT	Lúmenes	LED	Apertura	Voltaje	CRI	IP	Material
35-2703-WW	E12	5W	2700K	600	Filamento	360°	110-130V	>80	20	Aluminio + Cristal
45-1204-WW	E12	5W	2700K	600	Filamento	360°	110-130V	>80	20	Aluminio + Cristal
35-1005-*	E12	4.5W	3000K / 5000K	340	SMD	180°	110-130V	>80	20	Aluminio + PC

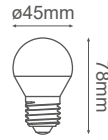

45-1004-*

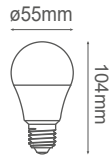

60-1007-*

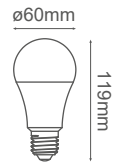

60-1011-*

E26

Modelo	Base	Watts	CT	Lúmenes	LED	Apertura	Voltaje	CRI	IP	Material
45-1004-*	E26	4.5W	3000K / 4000K / 6000K	400	SMD	180°	110-130V	>80	20	Aluminio + PC
60-1007-*	E26	7W	3000K / 4000K / 6000K	560	SMD	270°	110-130V	>80	20	Aluminio + PC
60-1011-*	E26	11W	3000K / 4000K / 6000K	1050	SMD	270°	110-130V	>80	20	Aluminio + PC





45-2604-WW 



45-2704-WW



64-2706-WW 

Modelo	Base	Watts	CT	Lúmenes	LED	Apertura	Voltaje	CRI	IP	Material
45-2604-WW	E26	5W	2700K	400	Filamento	360°	110-130V	>80	20	Aluminio + Cristal 
45-2704-WW	E26	4W	2700K	340	Filamento	360°	110-130V	>80	20	Aluminio + Cristal 
64-2706-WW	E26	5W	2700K	400	Filamento	360°	110-130V	>80	20	Aluminio + Cristal 



80-2003-*



30-0412-WW

PAR20 | PAR30

Modelo	Base	Bulbo	Watts	CT	Lúmenes	LED	Apertura	Voltaje	CRI	IP	Material
80-2003-*	E26	PAR20	9W	3000K / 4000K	720	SMD	38°	100-240V	>80	20	Alum + PC
30-0412-WW	E26	PAR30	12W	3000K	960	SMD	38°	100-240V	>80	20	Alum + PC



80-3002-*



80-1112-* | 80-1112-D 



80-1015-WW

Modelo	Base	Bulbo	Watts	CT	Lúmenes	LED	Apertura	Voltaje	CRI	IP	Material
80-3002-*	E26	PAR30	10W	3000K / 4000K	800	SMD	45°	85-265V	>80	20	Aluminio + PC
80-1112-*	AR111	AR111	12W	3000K / 4000K	960	COB	20°	90-240V	>80	20	Aluminio
80-1015-WW	G53	AR111	13W	3000K	1200	SMD	24°	12V AC/DC	>80	20	Aluminio + PC



LED SMD 4014

ACCESORIOS:



CON-22840



CON-840

*Incluidos



CON-15840



CBL-22840

*Se venden por separado.



22-8401-*

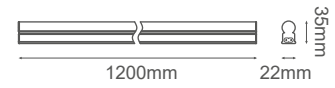

22-8403-*

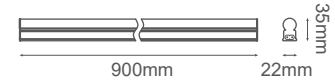

22-8402-*

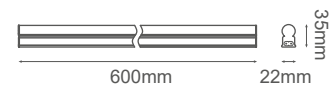

22-8404-*

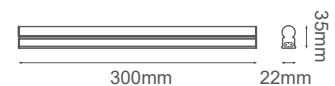

NOTA: Interconectable hasta 8 piezas. Sistema de Fijación incluido.

Modelo	Base	Watts	CT	Lúmenes	LED	Apertura	Voltaje	CRI	IP	Material
22-8401-*	T5	18W	3000K / 4500K	1980	SMD	120°	100-240V	>80	20	PC
22-8402-*	T5	9W	3000K / 4500K	1100	SMD	120°	100-240V	>80	20	PC
22-8403-*	T5	12W	3000K / 4000K	1200	SMD	120°	100-240V	>80	20	PC
22-8404-*	T5	5W	3000K / 4500K	450	SMD	120°	100-240V	>80	20	PC



00-2902-65

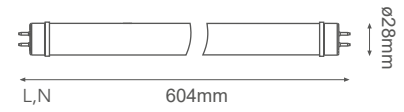

00-2922-*

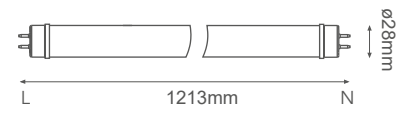

00-2918-41

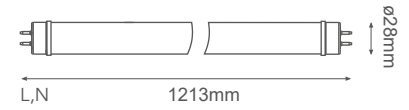

00-1218-*

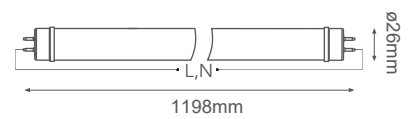

Modelo	Base	Watts	CT	Lúmenes	LED	Apertura	Voltaje	CRI	IP	Material
00-2902-*	T8	10W	3000K / 4100K / 6000K	1000	SMD 2835	240°	100-240V	>80	20	Cristal + PET
00-2922-*	T8	18W	3000K / 4100K / 6000K	1800	SMD 2835	240°	100-240V	>80	20	Cristal + PET
00-2918-41	T8	18W	4100K	1800	SMD 2835	240°	100-277V	>80	20	Cristal + PET
00-1218-*	T8	18W	3000K / 4000K	1620	SMD 2835	240°	85-265V	>80	20	Cristal + PET



DOWNLIGHTS BASIC



06-0321-*

-01 Blanco -07 Negro



06-0322-*

-01 Blanco -07 Negro



06-0323-*

-01 Blanco -07 Negro

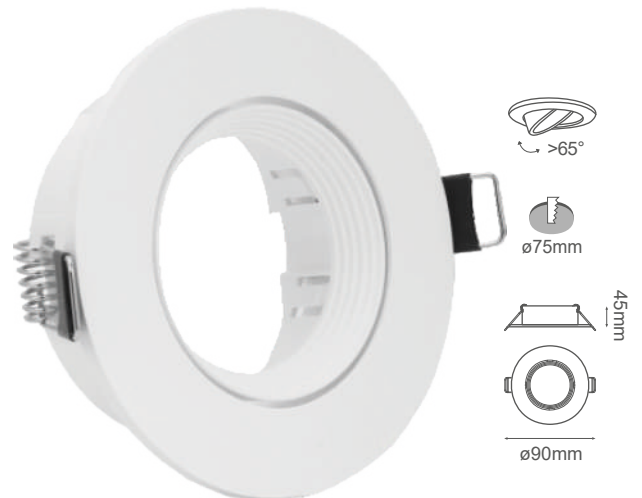

06-0325-*

-01 Blanco -07 Negro

NOTA: Soquet incluido. Foco se vende por separado.

Modelo	Base	Foco	Watts	Voltaje	IP	Material
06-0321-*	GU10	MR16	Máx. 12W	127V	20	PC
06-0322-*	GU10	MR16	Máx. 12W	127V	20	PC
06-0323-*	GU10	MR16	Máx. 12W	127V	20	PC
06-0325-*	GU10	MR16	Máx. 12W	127V	20	PC

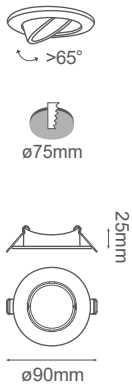

06-0326-*

-01 Blanco -07 Negro

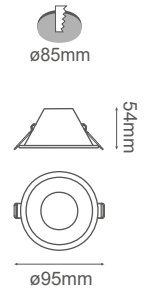

06-0329-*

-01 Blanco -07 Negro

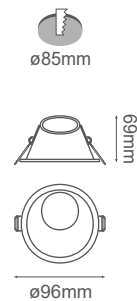

06-3210-*

-01 Blanco -07 Negro

NOTA: Soquet incluido. Foco se vende por separado.

Modelo	Base	Foco	Watts	Voltaje	IP	Material
06-0326-*	GU10	MR16	Máx. 12W	127V	20	PC
06-0329-*	GU10	MR16	Máx. 12W	127V	20	PC
06-3210-*	GU10	MR16	Máx. 12W	127V	20	PC



06-3211-*

-01 Blanco -07 Negro

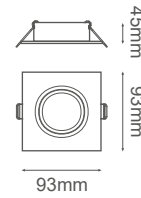

06-3212-*

-01 Blanco -07 Negro

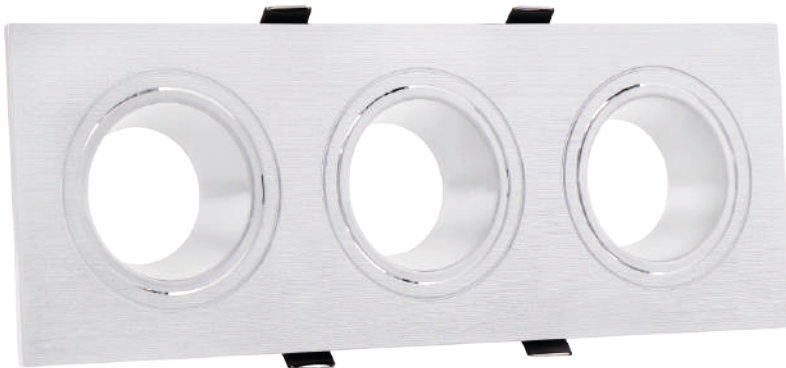
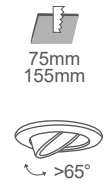
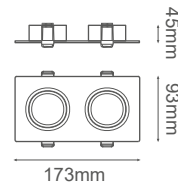

06-3213-*

-01 Blanco -07 Negro

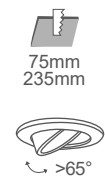
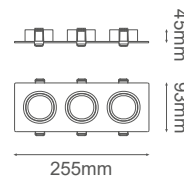

NOTA: Soquet incluido. Foco se vende por separado.

Modelo	Base	Foco	Watts	Voltaje	IP	Material
06-3211-*	GU10	MR16	Máx. 12W	127V	20	PC
06-3212-*	GU10	MR16	Máx. 12W	127V	20	PC
06-3213-*	GU10	MR16	Máx. 12W	127V	20	PC



06-0353-*

-01 Blanco -07 Negro

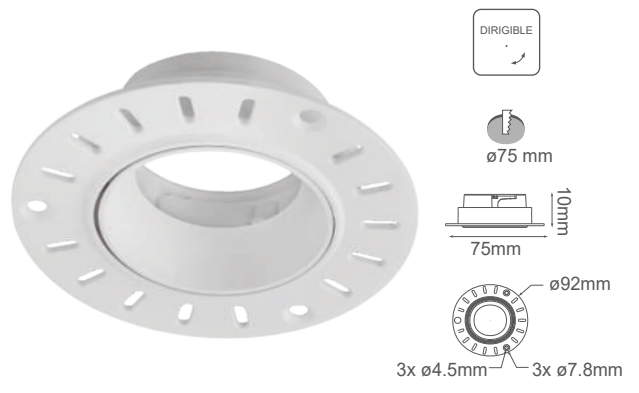

06-0357-*

-01 Blanco -07 Negro



06-0361-*

-01 Blanco -07 Negro



06-0370-*

-01 Blanco -07 Negro

NOTA: Soquet incluido. Foco se vende por separado.

Modelo	Base	Foco	Watts	Voltaje	IP	Material
06-0353-*	GU10	MR16	Máx.12W	127V	20	PC
06-0357-*	GU10	MR16	Máx.12W	127V	20	PC
06-0361-*	GU10	MR16	Máx.12W	127V	20	PC
06-0370-*	GU10	MR16	Máx.12W	127V	65	PC



11-3202-*

-01 Blanco -07 Negro



22-3204-*

-01 Blanco -07 Negro



¡Dos tipos de instalación!
Empotrado y a Cánopé

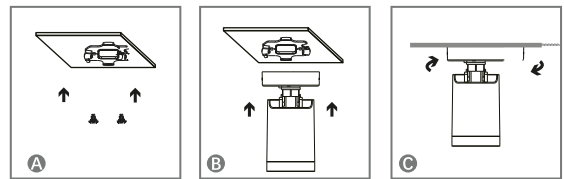

Modelo	Base	Foco	Watts	Voltaje	IP	Material
11-3202-*	GU10	MR16	Máx. 12W	127V	20	PC
22-3204-*	GU10	MR16	Máx. 12W	127V	20	PC



06-3155-*

-01 Blanco -02 Satinado -07 Negro

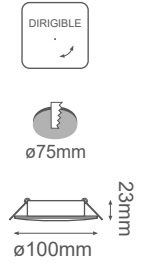

06-3254-*

-01 Blanco -02 Satinado -07 Negro



06-3198-*

-01 Blanco -07 Negro

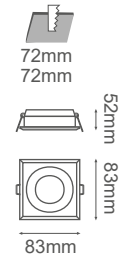

06-3199-*

-01 Blanco -07 Negro

NOTA: Soquet incluido. Foco se vende por separado.

Modelo	Base	Foco	Watts	Voltaje	IP	Material
06-3155-*	GU10	MR16	Máx. 12W	127V	20	Aluminio
06-3254-*	GU10	MR16	Máx. 12W	127V	20	Aluminio
06-3198-*	GU10	MR16	Máx. 12W	127V	20	Aluminio
06-3199-*	GU10	MR16	Máx. 12W	127V	20	Aluminio



66-3407-*

-01 Blanco -06 Cromo

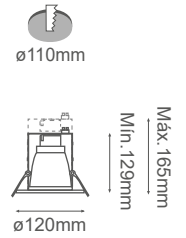

06-2283-*

-01 Blanco -02 Satinado

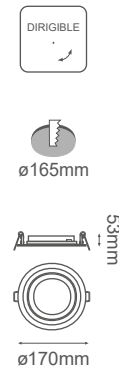

06-2489-*

-01 Blanco

NOTA: Soquet incluido. Foco se vende por separado.

Modelo	Base	Foco	Watts	Voltaje	IP	Material
66-3407-*	GU10	MR16	Máx. 12W	127V	65	Aluminio + Cristal
06-2283-*	E26	E26	Máx. 60W	127V	20	Aluminio + Cristal
06-2489-*	G53	AR111	Máx. 50W	127V	20	Aluminio

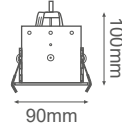

06-4401-*

-01 Blanco

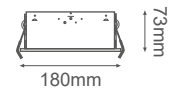

06-4402-*

-01 Blanco -03 Gris

NOTA: Soquet incluido. Foco se vende por separado.

Modelo	Base	Foco	Watts	Voltaje	IP	Material
06-4401-*	GU10	MR16	Máx.12W	127V	20	Aluminio
06-4402-*	GU5.3	MR16	Máx.12W	12V /127V	20	Aluminio + Acero



06-3208-*

-01 Blanco -07 Negro



06-3207-*

-01 Blanco -07 Negro

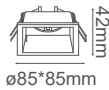

06-3106-*

-01 Blanco -07 Negro

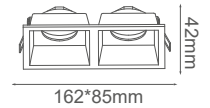

06-3206-*

-01 Blanco -07 Negro

NOTA: Soquet incluido. Foco se vende por separado.

Modelo	Base	Foco	Watts	Voltaje	IP	Material
06-3208-*	GU10	MR16	Máx.7W	127V	20	Aluminio
06-3207-*	GU10	MR16	Máx.7W	127V	20	Aluminio
06-3106-*	GU10	MR16	Máx.7W	127V	20	Aluminio
06-3206-*	GU10	MR16	Máx.7W	127V	20	Aluminio

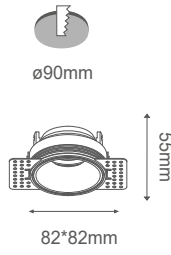

06-3123-*

-01 Blanco

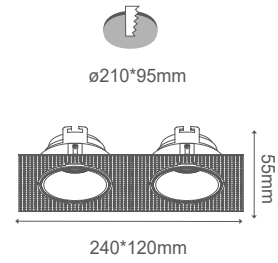

06-3124-*

-01 Blanco



NOTA: Soquet incluido. Foco se vende por separado.

Modelo	Base	Foco	Watts	Voltaje	IP	Material
06-3123-*	GU10	MR16	Máx.7W	127V	20	Aluminio
06-3124-*	GU10	MR16	Máx.7W	127V	20	Aluminio



06-2901-*

-01 Blanco -07 Negro

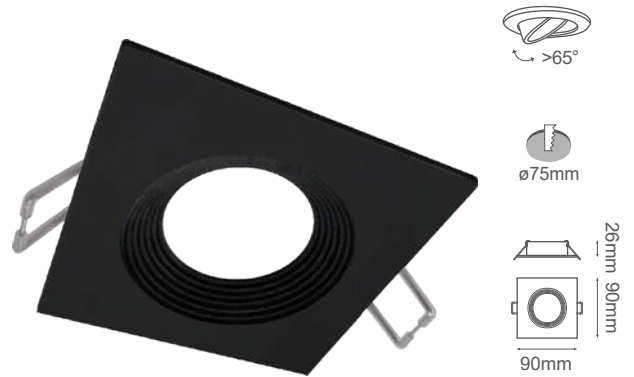

06-2904-*

-01 Blanco -07 Negro



06-2905-*

-01 Blanco -07 Negro



06-2906-*

-01 Blanco -07 Negro

*NOTA: Soquet y demás accesorios se venden por separado.

Modelo	Fuente Luminosa (Accesorios*)	IP	Material
06-2901-*	Foco de Bulbo MR16, Base GU10 / Módulo dimeable de LED 7W ó 12W	20	Aluminio
06-2904-*	Foco de Bulbo MR16, Base GU10 / Módulo dimeable de LED 7W ó 12W	20	Aluminio
06-2905-*	Foco de Bulbo MR16, Base GU10 / Módulo dimeable de LED 7W ó 12W	20	Aluminio
06-2906-*	Foco de Bulbo MR16, Base GU10 / Módulo dimeable de LED 7W ó 12W	20	Aluminio



06-2907-*

-01 Blanco -07 Negro

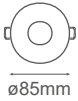

06-2910-*

-01 Blanco -07 Negro



06-2911-*

-01 Blanco -07 Negro

*NOTA: Soquet y demás accesorios se venden por separado.

Modelo	Fuente Luminosa (Accesorios*)	IP	Material
06-2907-*	Foco de Bulbo MR16, Base GU10 / Módulo dimeable de LED 7W ó 12W	20	Aluminio
06-2910-*	Foco de Bulbo MR16, Base GU10 / Módulo dimeable de LED 7W ó 12W	20	Aluminio
06-2911-*	Foco de Bulbo MR16, Base GU10 / Módulo dimeable de LED 7W ó 12W	20	Aluminio



06-3901-*

-01 Blanco -07 Negro



105mm

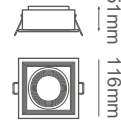

116mm



>65°



360°



06-3902-*

-01 Blanco -07 Negro

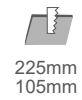

105mm

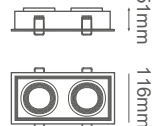

236mm

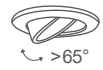

>65°



360°



06-3903-*

-01 Blanco -07 Negro



105mm

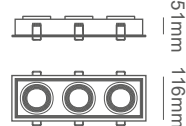

342mm



>65°



360°

*NOTA: Soquet y demás accesorios se venden por separado.

Modelo	Fuente Luminosa (Accesorios*)	IP	Material
06-3901-*	Foco de Bulbo MR16, Base GU10 / Módulo dimeable de LED 7W ó 12W	20	Aluminio
06-3902-*	Foco de Bulbo MR16, Base GU10 / Módulo dimeable de LED 7W ó 12W	20	Aluminio
06-3903-*	Foco de Bulbo MR16, Base GU10 / Módulo dimeable de LED 7W ó 12W	20	Aluminio

Opción 1: Foco + Soquet

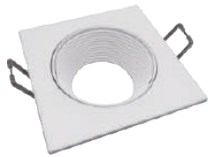

Downlight
serie NOX

+



ARO-2912
Incluido

+



Foco MR16
Se vende por separado

+



SQT-GU10
Se vende por separado

NOTA: Retirar ARO-2912 si va a usar Módulo LED.

Opción 2: Módulos de LED 7W ó 12W Dimeables

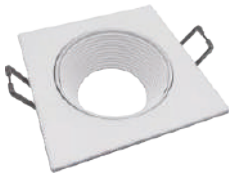

Downlight
serie NOX

+



Módulos de LED 7W ó 12W
Se vende por separado

Modelo	Watts	CT	Lúmenes	Apertura	Voltaje	CRI	IP	Material	
6-29007-*	7W	3000K	560	36°	110V	>80	20	Aluminio	
	7W	4000K	560	36°	110V	>80	20	Aluminio	
6-29012-*	12W	3000K	960	36°	110V	>80	20	Aluminio	
	12W	4000K	960	36°	110V	>80	20	Aluminio	

Sugerencia de uso



06-2906-01 + Módulo LED



06-2907-01 + Módulo LED



06-2910-01 + Módulo LED

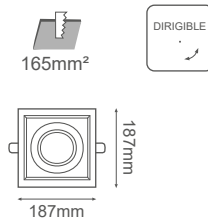

6-51112-*

-01 Blanco -07 Negro

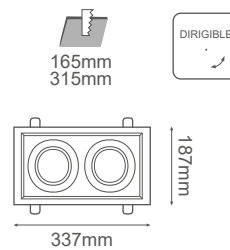

6-52112-*

-01 Blanco -07 Negro

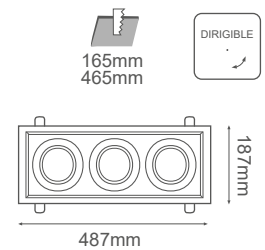

6-53112-*

-01 Blanco -07 Negro

NOTA: Focos incluidos. Opción de foco dimeable 80-1112-D, página 08, se vende por separado.

Modelo	Watts	CT	Lúmenes	LED	Apertura	Voltaje	CRI	IP	Material
6-51112-*	12W	3000K / 4000K	960	COB	24°	90-240V	>80	20	Aluminio + PMMA
6-52112-*	2x12W	3000K / 4000K	1920	COB	24°	90-240V	>80	20	Aluminio + PMMA
6-53112-*	3x12W	3000K / 4000K	2880	COB	24°	90-240V	>80	20	Aluminio + PMMA

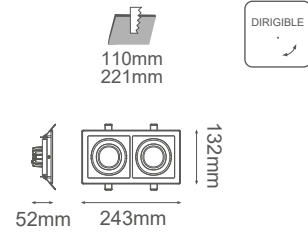

6-12554-*



-01 Blanco -07 Negro

APOLO

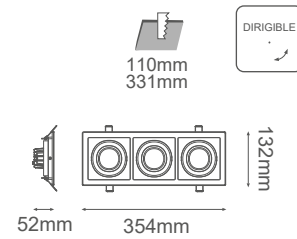

6-12654-*

-01 Blanco -07 Negro

Accesorio Dimmer ACT-26752-D se vende por separado

Modelo	Watts	CT	Lúmenes	LED	Apertura	Voltaje	CRI	IP	Material
6-12554-*	18W	3000K / 4000K	1200	COB	24°	90-130V / 110V	>80	20	Aluminio 
6-12654-*	27W	3000K / 4000K	1800	COB	24°	90-130V	>80	20	Aluminio



GYPSUM





Luminarios hechos a base de yeso, especialmente diseñados para colocar en plafones de tablaroca. Con un efecto final invisible que enriquece la atmósfera de cualquier habitación.

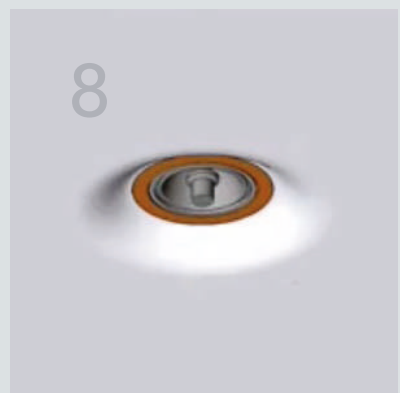
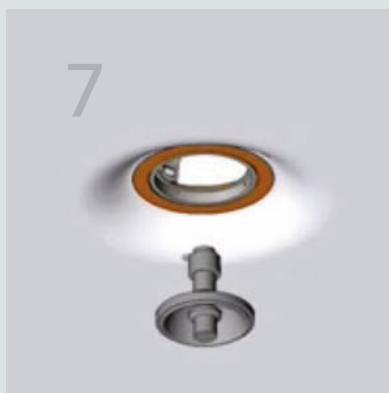
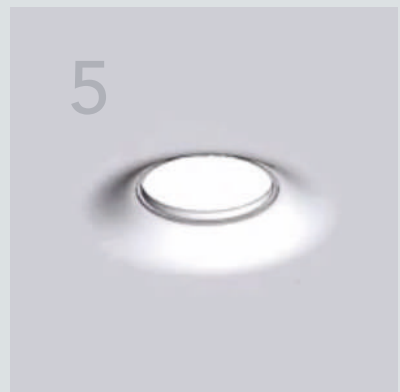
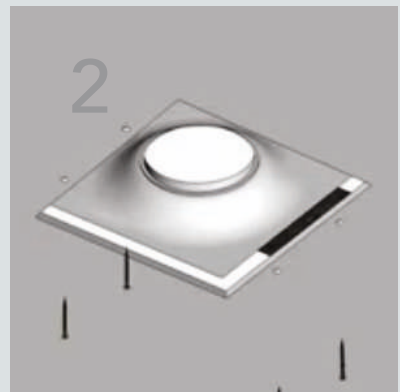

GYPSUM



06-9132-10

-10 Yeso



06-9129-10

-10 Yeso



06-9130-10

-10 Yeso



06-9131-10

-10 Yeso



06-9229-10

-10 Yeso

NOTA: Soquet incluido. Foco se vende por separado.

Modelo	Base	Foco	Watts	Voltaje	IP	Material
06-9132-10	GU10	MR16	Máx. 12W	127V	20	Yeso
06-9129-10	GU10	MR16	Máx. 12W	127V	20	Yeso
06-9130-10	GU10	MR16	Máx. 12W	127V	20	Yeso
06-9131-10	GU10	MR16	Máx. 12W	127V	20	Yeso
06-9229-10	GU10	MR16	Máx. 12W	127V	20	Yeso



06-9224-10

-10 Yeso



06-9285-10

-10 Yeso



06-9442-10

-10 Yeso

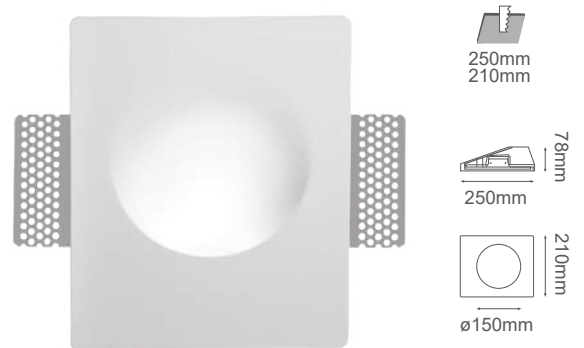

08-3013-10

-10 Yeso

NOTA: Soquet incluido. Foco se vende por separado.

Modelo	Base	Foco	Watts	Voltaje	IP	Material
06-9224-10	GU10	MR16	Máx. 12W	127V	20	Yeso
06-9285-10	GU10	MR16	Máx. 12W	127V	20	Yeso
06-9442-10	G53	AR11	Máx. 50W	12V / 127V	20	Yeso
08-3013-10	GU10	MR16	Máx. 12W	127V	20	Yeso

*Para plafón de tablaroca 12mm

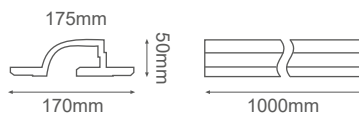
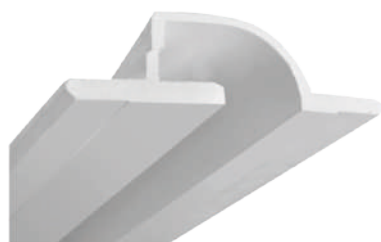

06-9703-10

-10 Yeso

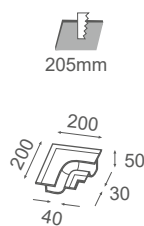

06-9703-D

-10 Yeso



06-9703-TD

-10 Yeso

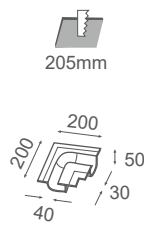

06-9703-I

-10 Yeso

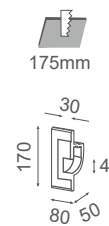

06-9703-TI

-10 Yeso

NOTA: Tira LED se vende por separado.

Modelo	Base	Voltaje	IP	Material
06-9703-10	Para tira de LED	127V	20	Yeso
06-9703-D	Para tira de LED	127V	20	Yeso
06-9703-I	Para tira de LED	127V	20	Yeso
06-9703-TD	Para tira de LED	127V	20	Yeso
06-9703-TI	Para tira de LED	127V	20	Yeso



DOWNLIGHTS



ø135mm

69mm
ø140mm

06-9033-10

-10 Yeso



90°

ø93mm

71mm
ø110mm

06-9034-*

-01 Blanco



350° 90°

ø93mm

90mm
ø100mm

06-9035-*

-01 Blanco



350° 90°

103mm
ø100mm

22-9036-*

-01 Blanco

Modelo	Watts	CT	Lúmenes	LED	Apertura	Voltaje	CRI	IP	Material
06-9033-10	11W	3000K	880	CREE PHILIPS	38°	90-130V	>80	20	Yeso
06-9034-*	13W	3000K	1040	CREE PHILIPS	38°	120V / 110V	>80	20	Aluminio
06-9035-*	13W	3000K	1040	CREE PHILIPS	38°	90-130V	>80	20	Aluminio
22-9036-*	13W	3000K	856	CREE PHILIPS	38°	120V / 110V	>80	20	Aluminio



06-6313-WW

-01 Blanco



ø33mm



30mm



ø40mm



06-2012-*

-01 Blanco -02 Satinado



45°



ø42mm



32mm
ø52mm

*Driver remoto incluido.



06-2314-WW

-01 Blanco -07 Negro



45°



ø69mm

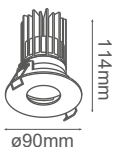

14mm
ø90mm



06-2315-WW

-01 Blanco -07 Negro



45°



ø69mm



14mm
ø90mm

NOTA: Driver incluido.

Modelo	Watts	CT	Lúmenes	LED	Apertura	Voltaje	CRI	IP	Material
06-6313-*	3W	3000K / 4000K	215	CREE XPE	40°	85-265V	>80	20	Aluminio
06-2012-*	2.2W	3000K / 4000K	145	CREE SMD	40°	127V	>80	20	Aluminio
06-2314-WW	10W	3000K	660	SMD	24°	120-277V	>80	20	Aluminio
06-2315-WW	10W	3000K	750	SMD	24°	120-277V	>80	20	Aluminio

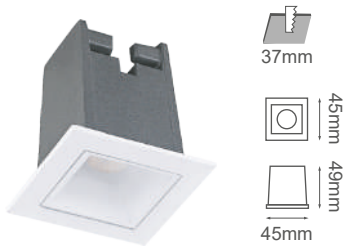

06-7091-*

-01 Blanco -07 Negro

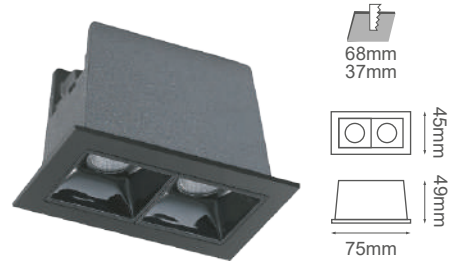

06-7092-*

-01 Blanco -07 Negro

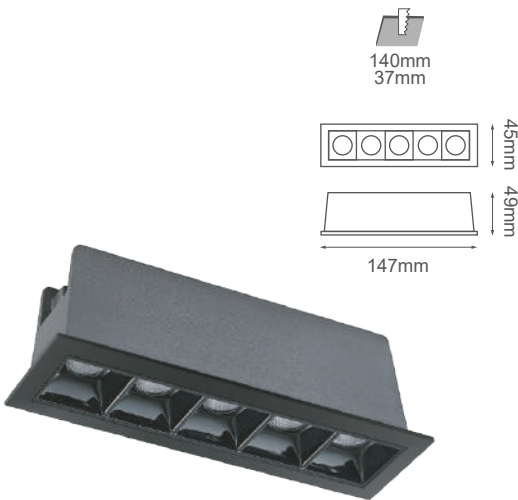

06-7095-*

-01 Blanco -07 Negro

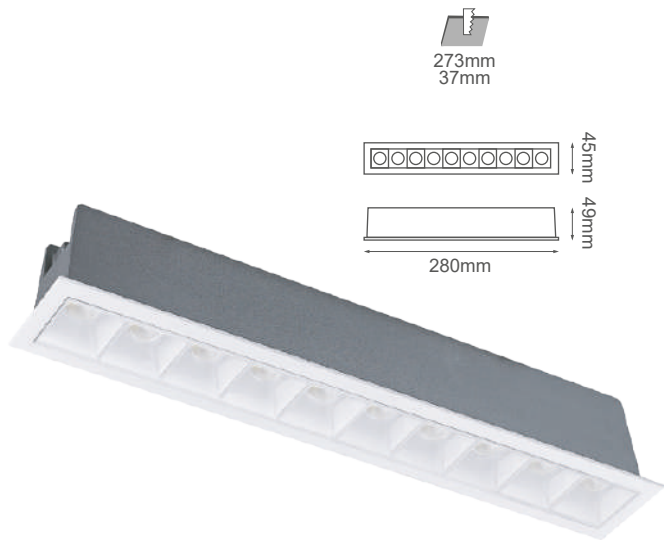

06-7010-*

-01 Blanco -07 Negro

Modelo	Watts	CT	Lúmenes	LED	Apertura	Voltaje	CRI	IP	Material
06-7091-*	2W	3000K	160	OSRAM	30°	100-265V	90	20	Aluminio
06-7092-*	4W	3000K	320	OSRAM	30°	100-265V	90	20	Aluminio
06-7095-*	10W	3000K	800	OSRAM	30°	100-265V	90	20	Aluminio
06-7010-*	20W	3000K	1600	OSRAM	30°	100-265V	90	20	Aluminio

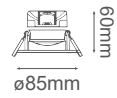

06-1070-*

-01 Blanco

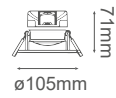

06-1090-*

-01 Blanco

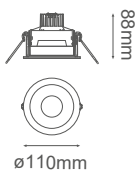

6-26951-*

-01 Blanco

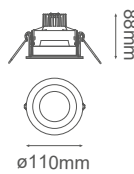

6-26957-NW

-01 Blanco



Modelo	Watts	CT	Lúmenes	LED	Apertura	Voltaje	CRI	IP	Material
06-1070-*	7W	3000K / 4000K	650	SMD	36°	100-265V	>80	20	Plástico + Alum
06-1090-*	10W	3000K / 4000K	950	SMD	36°	100-265V	>80	20	Plástico + Alum
6-26951-*	9W	3000K / 4000K	380	COB EPISTAR	25°	90-130V	>80	20	Aluminio
6-26957-NW	9W	4000K	698	COB EPISTAR	35°	110-240V	>80	20	Aluminio



SKY

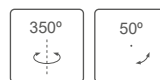
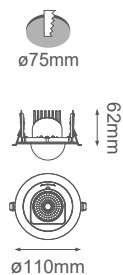

6-27051-NW

-01 Blanco



6-28151-NW

-01 Blanco

Modelo	Watts	CT	Lúmenes	LED	Apertura	Voltaje	CRI	IP	Material
6-27051-NW	9W	4000K	698	COB EPISTAR	18°	100-240V	>80	20	Aluminio
6-28151-NW	9W	4000K	600	COB EPISTAR	25°	90-240V	>80	20	Aluminio

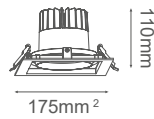

Accesorio

*Se vende por separado

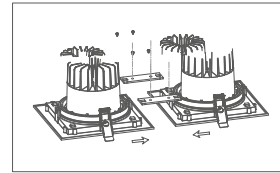

CON-060113
Conexión modular

06-0113-*



-01

Blanco

-07

Negro

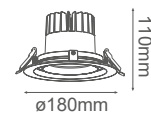

06-0114-*



-01

Blanco

-07

Negro

NOTA: Driver TRIAC incluido.

Modelo	Watts	CT	Lúmenes	LED	Apertura	Voltaje	CRI	IP	PF	Material
06-0113-*	25W	3000K / 5000K	2600	COB	36°	120V / 110V	>80	20	0.9	Aluminio
06-0114-*	25W	3000K / 5000K	2600	COB	36°	120V / 110V	>80	20	0.9	Aluminio

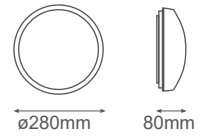

22-0128-NW

-01 Blanco

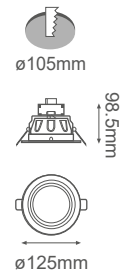

6-21701-*

-01 Blanco

NOTA: Driver incluido.

Modelo	Watts	CT	Lúmenes	LED	Apertura	Voltaje	CRI	IP	Material
22-0128-NW	12W	4000K	1020	SMD	120°	100-277V	>80	20	Aluminio + Plástico
6-21701-*	7W	3000K / 4000K	550	SMD 5630	90°	100-240V / 110V	>80	20	Aluminio



06-3108-* | 06-3108-*D

-01 Blanco -07 Negro



06-3110-* | 06-3110-*D

-01 Blanco -07 Negro



06-3117-* | 06-3117-*D

-01 Blanco -07 Negro



06-3125-*

-01 Blanco

*D = Dimeable

*NOVA acabado Negro -07 sólo disponible en versión Dimeable

Modelo	Watts	CT	Lúmens	LED	Apertura	Voltaje	CRI	IP	Material
06-3108-* 06-3108-*D	8W	3000K / 4100K	680	SMD	90°	100-277V	>80	20 / 44	Aluminio + Tapa plástica
06-3108-07-*D	8W	3000K / 4100K	680	SMD	90°	100-277V	>80	20 / 44	Aluminio + Tapa plástica
06-3110-* 06-3110-*D	12W	3000K / 4100K	1050	SMD	90°	100-277V	>80	20 / 44	Aluminio + Tapa plástica
06-3110-07-*D	12W	3000K / 4100K	1050	SMD	90°	100-277V	>80	20 / 44	Aluminio + Tapa plástica
06-3117-* 06-3117-*D	17W	3000K / 4100K	1670	SMD	90°	100-277V	>80	20 / 44	Aluminio + Tapa plástica
06-3117-*	17W	3000K / 4100K	1670	SMD	90°	100-277V	>80	20 / 44	Aluminio + Tapa plástica
06-3125-*	25W	3000K / 4100K	2230	SMD	90°	100-277V	>80	20 / 44	Aluminio + Tapa plástica

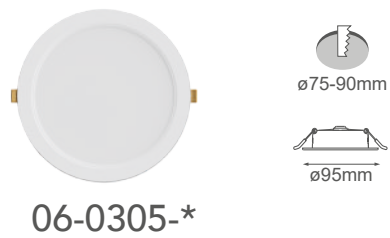
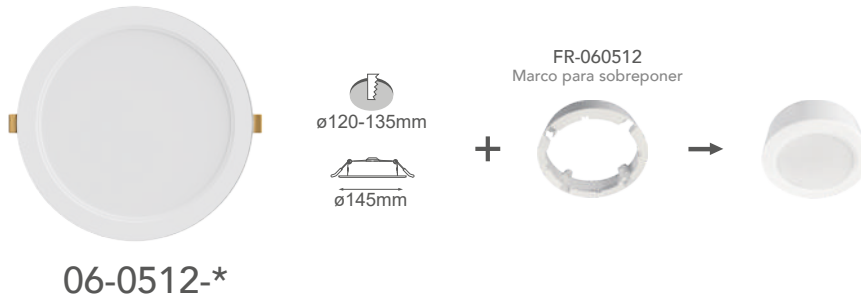

NOTA: Marcos para sobreponer se venden por separado.

Modelo	Watts	CT	Lúmens	Apertura	Voltaje	CRI	IP	Material
06-1224-*	24W	4100K	2400lm	90°	100-240V	>80	20	PC
06-0718-*	18W	3000K / 4100K	1800lm	90°	100-240V	>80	20	PC
06-0512-*	12W	3000K / 4100K	1200lm	90°	100-240V	>80	20	PC
06-0409-*	9W	3000K / 4100K	900lm	90°	100-240V	>80	20	PC
06-0305-*	5W	3000K / 4100K	500lm	90°	100-240V	>80	20	PC



PROFESIONAL

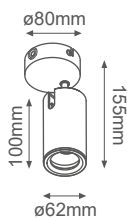

22-2409-*

-01 Blanco -07 Negro

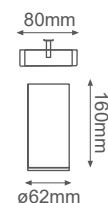
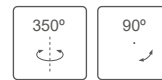

11-2409-*

-01 Blanco -07 Negro

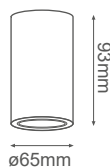

22-6503-*

-01 Blanco -07 Negro

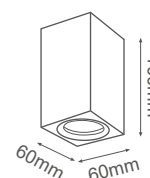

22-6504-*

-01 Blanco -07 Negro

NOTA: Focos y Riel se venden por separado.

Modelo	Base	Foco	Watts	Voltaje	IP	Material
22-2409-*	GU10	MR16	Máx. 12W	100-240V	20	Aluminio
11-2409-*	GU10	MR16	Máx. 12W	100-240V	20	Aluminio
22-6503-*	GU10	MR16	Máx. 12W	100-240V	20	Aluminio
22-6504-*	GU10	MR16	Máx. 12W	100-240V	20	Aluminio

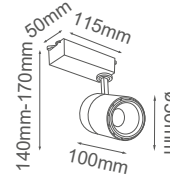

11-5009-*

-01 Blanco -07 Negro

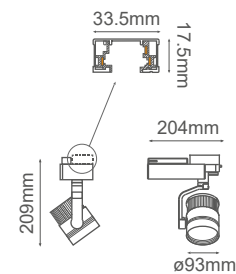
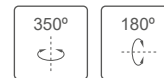

11-3001-*

-01 Blanco

NOTA: Driver incluido. Riel se vende por separado.

Modelo	Watts	CT	Lúmenes	LED	Apertura	Voltaje	CRI	IP	Material
11-5009-*	10W	3000K / 4500K	950	COB <u>bridgelux</u> .	24°	100-240V	>95	20	Aluminio
11-3001-*	28W	4000K	1830	COB CREE	24°	100-240V	>80	20	Aluminio



22-3002-*

-01 Blanco

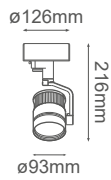

11-1735-*

-01 Blanco -07 Negro



Ángulo ajustable
10° a 60°

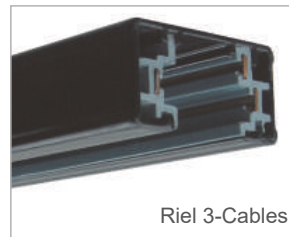
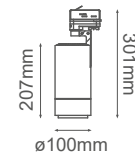
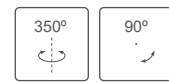

Riel 3-Cables

Nota: Todos nuestros luminarios a riel deben ser instalados usando un riel de 3 cables.

NOTA: Driver incluido. Riel se vende por separado.

Modelo	Watts	CT	Lúmenes	LED	Apertura	Voltaje	CRI	IP	Material
22-3002-*	28W	4000K	1830lm	COB CREE	24°	100-240V	>80	20	Aluminio
11-1735-*	35W	3000K / 5000K	3450lm	COB CITIZEN	Ajustable 10° a 60°	100-240V	>80	20	Aluminio

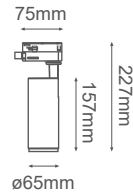
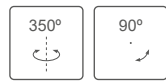

11-2815-*

-01 Blanco -07 Negro



Lente intercambiable a 45°
se vende por separado

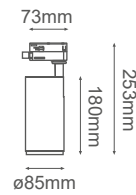
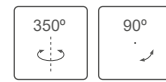

11-2825-*

-01 Blanco -07 Negro



Lente intercambiable a 36°
se vende por separado

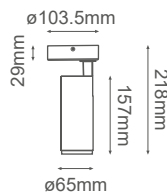
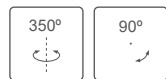

12-2815-*

-01 Blanco -07 Negro

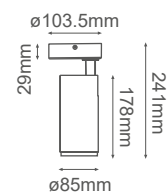
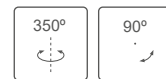

12-2825-*

-01 Blanco -07 Negro

NOTA: Lentes intercambiables, consultar ficha técnica.

Modelo	Watts	CT	Lúmenes	LED	Apertura	Voltaje	CRI	IP	Material
11-2815-*	15W	3000K / 5000K	1350lm	OSRAM COB	24°	100-240V	>90	20	Aluminio
11-2825-*	25W	3000K / 5000K	2250lm	OSRAM COB	24°	100-240V	>90	20	Aluminio
12-2815-*	15W	3000K	1350lm	OSRAM COB	24°	100-240V	>90	20	Aluminio
12-2825-*	25W	3000K	2250lm	OSRAM COB	24°	100-240V	>90	20	Aluminio

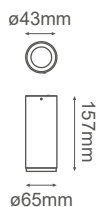

22-2815-*

-01 Blanco -07 Negro

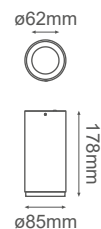

22-2825-*

-01 Blanco -07 Negro



LEN-2825-36

Lente intercambiable a 36°
se vende por separado

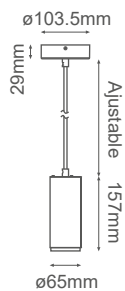

23-2815-*

-01 Blanco -07 Negro

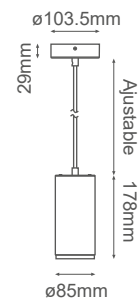

23-2825-*

-01 Blanco -07 Negro

NOTA: Lentes intercambiables, consultar ficha técnica.

Modelo	Watts	CT	Lúmenes	LED	Apertura	Voltaje	CRI	IP	Material
22-2815-*	15W	3000K	1350lm	COB	45°	100-240V	>90	20	Aluminio
22-2825-*	25W	3000K	2250lm	COB	60°	100-240V	>90	20	Aluminio
23-2815-*	15W	3000K	1350lm	COB	45°	100-240V	>90	20	Aluminio
23-2825-*	25W	3000K	2250lm	COB	60°	100-240V	>90	20	Aluminio

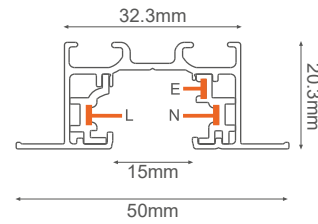

TR-0310-*

-01 Blanco -07 Negro

Longitud: 1m

TR-0320-*

-01 Blanco -07 Negro

Longitud: 2m

NOTA: Todos los rieles incluyen un Conector inicial y una Tapa final XR-366-*



XR-361L-*

Acometida izquierda



XR-361R-*

Acometida derecha



XR-363L-*

Conector en "L" izquierda



XR-363R-*

Conector en "L" derecha



XR-0362-*

Conector de continuidad



XR-0367-*

Conector de continuidad interno



XR-0366-*

Tapa final



XR-0364LL-*

Conector en "T" izquierda



XR-0364RL-*

Conector en "T" izquierda



XR-0364RR-*

Conector en "T" derecha



XR-0364LR-*

Conector en "T" derecha



XR-0365-*

Conector en "X"



XR-369L-*

Conector ángulo ajustable izquierda



XR-369R-*

Conector ángulo ajustable derecha

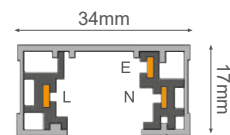
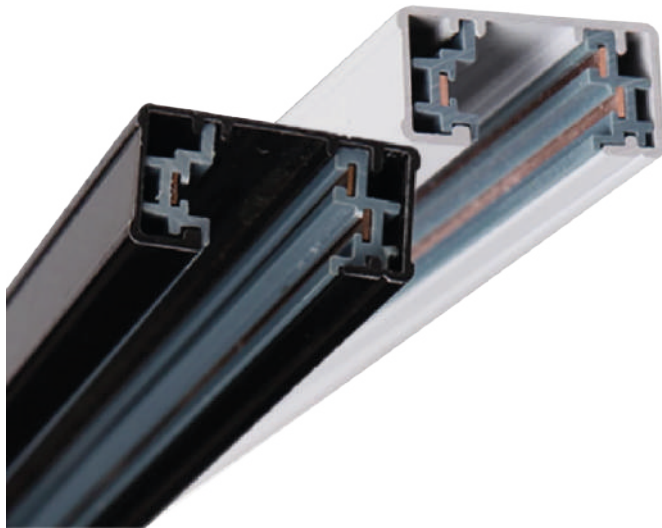

TRK-1000-*
-01 Blanco -07 Negro
Longitud: 1m

TRK-2000-*
-01 Blanco -07 Negro
Longitud: 2m

NOTA: Incluyen un Conector inicial y una Tapa final.



CON-I1-*
Acometida inicial



CON-B2-*
Conector de continuidad interno



CON-L3-*
Conector en "L"

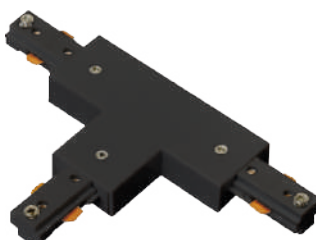

CON-T4-*
Conector en "T"

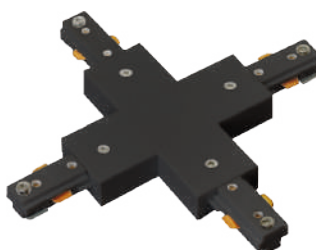
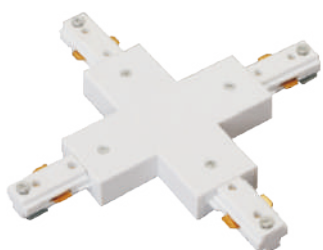

CON-X5-*
Conector en "X"



CON-F6-*
Conector flexible ángulo ajustable



23-1300-07

-07 Negro



23-1300-14

-14 Oro Cepillado



23-1300-01

-01 Blanco

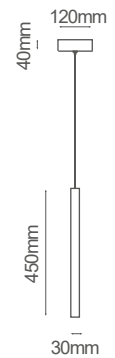

*Altura ajustable -3m de cable

23-1300-07

Modelo	Watts	CT	Lúmenes	LED	Apertura	Voltaje	CRI	IP	Material	
23-1300-07	6W	3000K	311lm	SMD	30°	100-240V	90	20	Aluminio	
23-1300-14	6W	3000K	311lm	SMD	30°	100-240V	90	20	Aluminio	
23-1300-01	6W	3000K	311lm	SMD	30°	100-240V	90	20	Aluminio	

SLIM





ATLAS

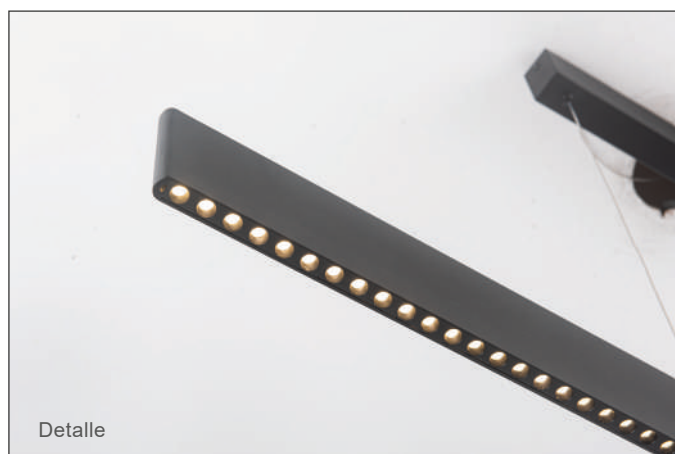

Detalle

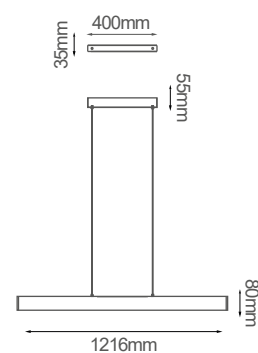

22-1130

-07 Negro

*Altura ajustable -3m de cable

Modelo	Watts	SWITCH CCT	Lúmens	LED	Apertura	Voltaje	CRI	IP	Material
22-1130	30W	3000K - 4000K - 6000K	1496lm	SMD	30°	127V	80	20	Aluminio



Track Magnético
ULTRA Delgado
30mm

Nuestro riel magnético tiene un delicado diseño para complementar cualquier espacio comercial o residencial.

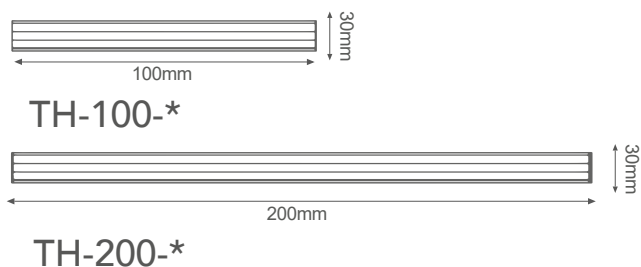

-07 Negro

-01 Blanco

Instalación de Riel Magnético:

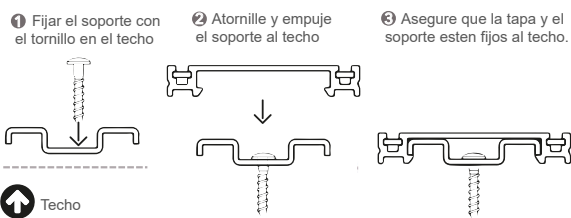

Fuente de poder 100W y 200W / 48V / IP20
M-TRA100 / M-TRA200

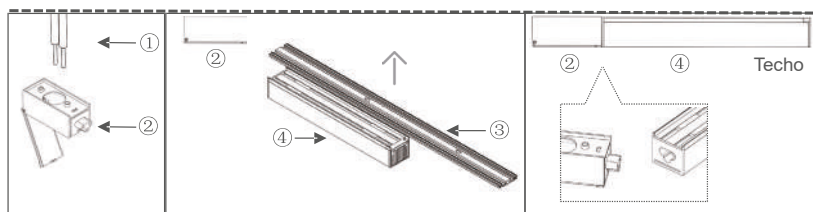

Conectores: -01 Blanco -07 Negro

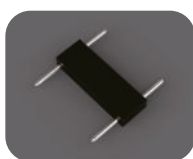

C-001-*

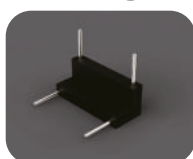

C-005P-*

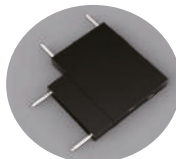

C-002L-*

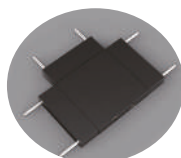

C-003T-*

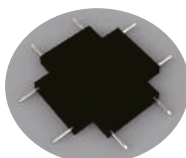

C-004C-*

● Inserte la clavija de cobre en el modulo principal

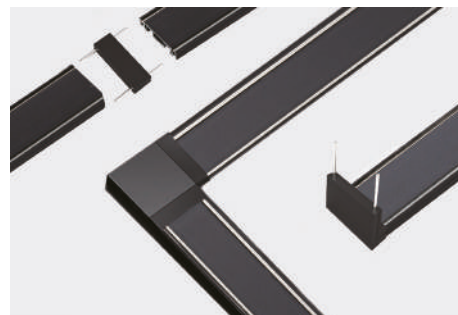

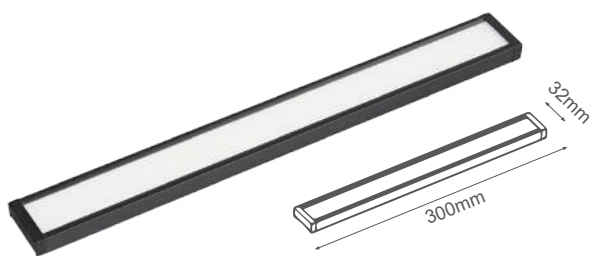

30-0300-*

-01 Blanco -07 Negro



30-0600-*

-01 Blanco -07 Negro

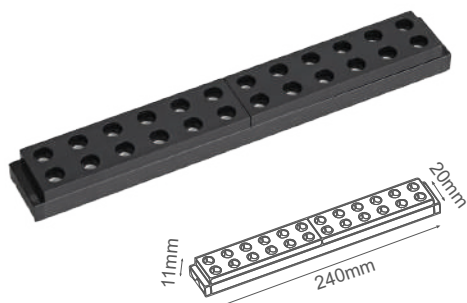

30-0024-*

-01 Blanco -07 Negro

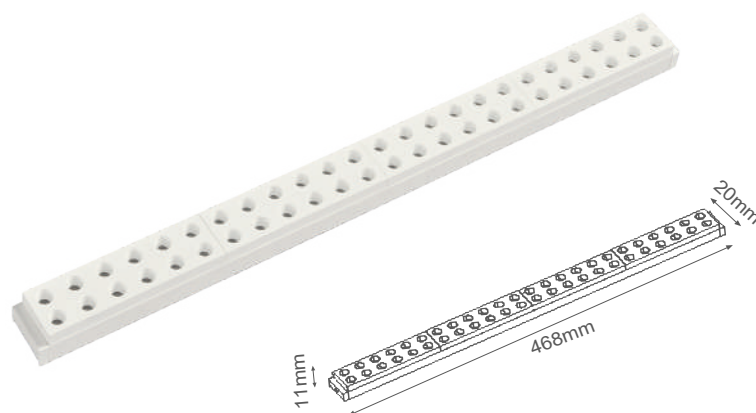

30-0048-*

-01 Blanco -07 Negro

Accesorios para del Track Magnetico

Modelo	Watts	CT	Lúmenes	LED	Apertura	Voltaje	CRI	IP	Material
30-0300-*	12W	3000K / 4000K	960lm	SMD	105°	48V	RA>90	20	Aluminio + PC
30-0600-*	24W	3000K / 4000K	1920lm	SMD	105°	48V	RA>90	20	Aluminio + PC
30-0024-*	10W	3000K / 4000K	800lm	SMD	30°	48V	RA>90	20	Aluminio + PC
30-0048-*	20W	3000K / 4000K	1600lm	SMD	30°	48V	RA>90	20	Aluminio + PC



30-0054-*

-01 Blanco -07 Negro



30-0055-*

-01 Blanco -07 Negro

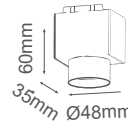

30-0811-*

-01 Blanco -07 Negro



30-2308-*

-01 Blanco -07 Negro

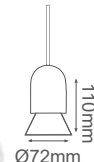

30-2307-*

-01 Blanco -07 Negro

Modelo	Watts	CT	Lúmenes	LED	Apertura	Voltaje	CRI	IP	Material
30-0054-*	8W	3000K / 4000K	640lm	SMD	24°	48V	RA>90	20	Aluminio + PC
30-0055-*	7W	3000K / 4000K	560lm	SMD	24°	48V	RA>90	20	Aluminio + PC
30-0811-*	5W	3000K / 4000K	360lm	SMD	260°	48V	RA>90	20	Aluminio + PC
30-2308-*	7W	3000K / 4000K	560lm	SMD	180°	48V	RA>90	20	Aluminio + PC
30-2307-*	7W	3000K / 4000K	560lm	SMD	180°	48V	RA>90	20	Aluminio + PC

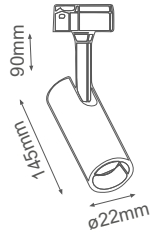

30-0007-*

-01 Blanco -07 Negro

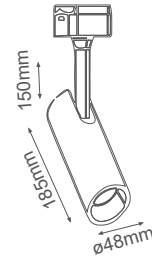

30-0012-*

-01 Blanco -07 Negro

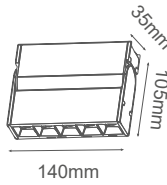

30-0510-*

-01 Blanco -07 Negro

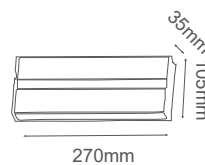
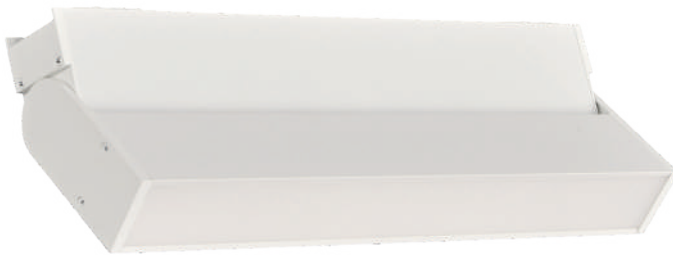

30-0010-*

-01 Blanco -07 Negro

Modelo	Watts	CT	Lúmenes	LED	Apertura	Voltaje	CRI	IP	Material
30-0007-*	7W	3000K / 4000K	56lm	SMD	24 / 36°	48V	RA>90	20	Aluminio + PC
30-0012-*	12W	3000K / 4000K	960lm	SMD	24 / 36°	48V	RA>90	20	Aluminio + PC
30-0510-*	12W	3000K / 4000K	800lm	SMD	30°	48V	RA>90	20	Aluminio + PC
30-0010-*	12W	3000K / 4000K	960lm	SMD	100°	48V	RA>90	20	Aluminio + PC



30-0500-*

30-1000-*

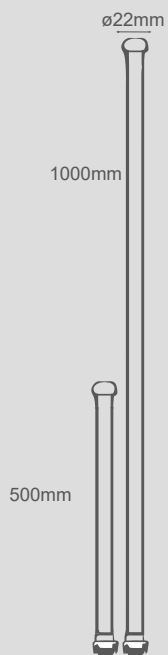

Modelo	Watts	CT	Lúmenes	LED	Apertura	Voltaje	CRI	IP	Material
30-0500-*	10W	3000K / 4000K	640lm	SMD	360°	48V	RA>90	20	Aluminio + PC
30-1000-*	20W	3000K / 4000K	1280lm	SMD	360°	48V	RA>90	20	Aluminio + PC

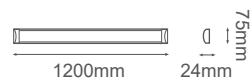

22-6136-DW

-01 Blanco

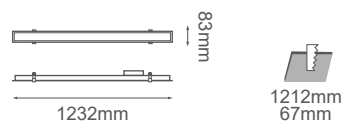

06-2011-*

-01 Blanco

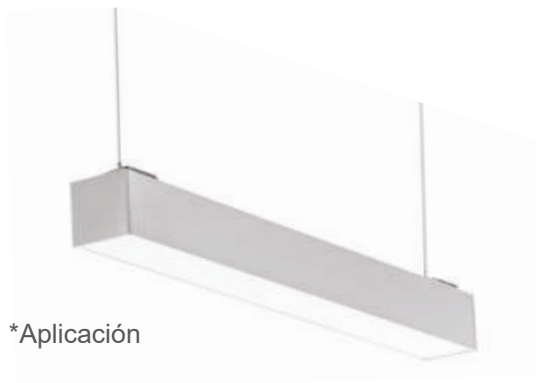

*Aplicación

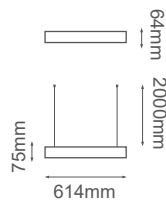

22-2060-WW

-03 Gris

ACCESORIO:



CON-2011

*Se vende por separado.

NOTA: Drivers y sistemas de fijación a techo incluidos.

Modelo	Watts	CT	Lúmenes	LED	Apertura	Voltaje	CRI	PF	IP	Material
22-6136-DW	36W	5000K	2880lm	SMD	120°	100-240V	>80	0.9	20	Aluminio + PC
06-2011-*	40W	3000K / 5000K	~3600lm	SMD	100°	100-240V	>80	0.9	20	Aluminio + PC
22-2060-WW	20W	3000K	1800lm	SMD	110°	100-240V	>80	-	20	Aluminio + PC

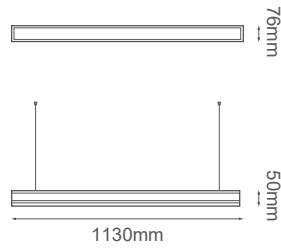
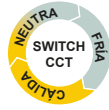

22-1232-*

-01 Blanco -07 Negro

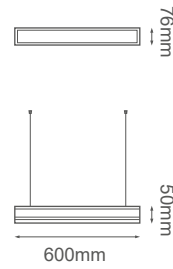

22-1216-*

-01 Blanco -07 Negro



Kit de sobreponer:
KIT-221232

LINE

Conectores:



CON-221232

Aluminio



Conector de continuidad interno.



CONL-221232-*

-01 Blanco -07 Negro



Conector de continuidad externo en "L"



CONT-221232-*

-01 Blanco -07 Negro

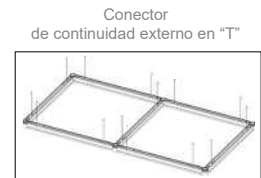

Conector de continuidad externo en "T"

Accesorios de interconexión: *Consultar ficha técnica

CON-221232-*/ CONL-221232-*/ CONT-221232-*/ CBL-221232

NOTA: Driver incluido. Accesorios se venden por separado.

Modelo	Watts	CCT	Lúmens	LED	Apertura	Voltaje	CRI	IP	Material
22-1232-*	32W	3000K / 4500K / 6000K	2580~3520lm	SMD	90°	100-240V	>80	20	Aluminio
22-1216-*	16W	3000K / 4500K / 6000K	1290~1760lm	SMD	90°	100-240V	>80	20	Aluminio

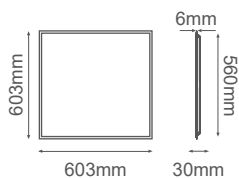

26-6640-40 | 26-6640-50

-01 Blanco

*Para empotrar

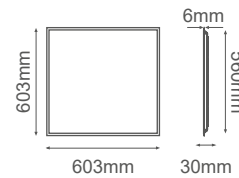

26-6640-CCT

-01 Blanco

*Para empotrar.

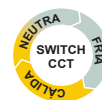

ACCESORIOS:



FR-2626-01
Marco para sobreponer



CBL-6640
Cables para suspender

*Se venden por separado.

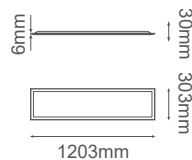
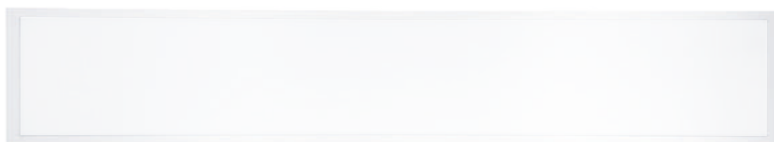

26-1340-40 | 26-1340-50

-01 Blanco

*Para empotrar.

ACCESORIOS:



FR-12060
Marco para sobreponer



CBL-6640
Cables para suspender

*Se venden por separado.

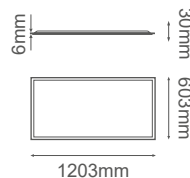
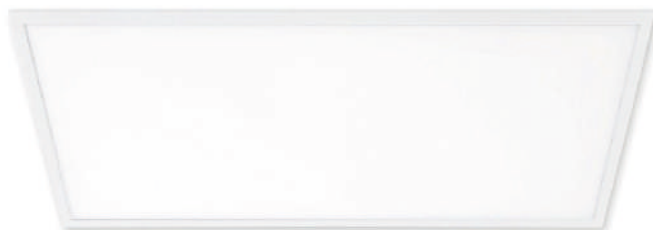

26-6675-50

-01 Blanco

*Para empotrar.

NOTA: Driver incluido. Accesorios se venden por separado.

Modelo	Watts	CT	Lúmenes	LED	Voltaje	CRI	PF	IP	Material
26-6640-*	40W	4000K / 5000K	3600lm	SMD	110-240V	>80	0.9	20	Aluminio
26-6640-CCT	40W	3000K / 4100K / 5000K	4000lm	SMD	110-240V	>80	0.9	20	Aluminio
26-1340-*	40W	4000K / 5000K	3600lm	SMD	85-265V	>80	0.9	20	Aluminio 6063 + PMMA
26-6675-50	75W	5000K	6700lm	SMD	85-265V	>80	0.9	20	Aluminio 6063 + PMMA



CORTESIA

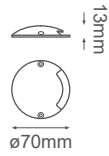

05-2801-* | 05-2807-*
(Kit 3 piezas)

-12 Aluminio

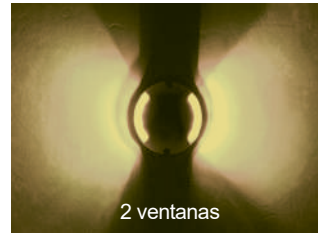
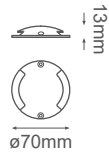

05-2800-* | 05-2806-*
(Kit 3 piezas)

-12 Aluminio

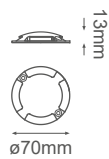

05-2799-* | 05-2805-*
(Kit 3 piezas)

-12 Aluminio

NOTA: Solo en KIT incluyen Transformador.

Modelo	Watts	CT	Lúmenes	LED	Voltaje	IP	Material
05-2801-* 05-2807-*	0.5W	3000K / 4000K / 5000K	20	5mm LED	12V CA/CD	67	Aluminio
05-2800-* 05-2806-*	0.8W	3000K / 4000K / 5000K	40	5mm LED	12V CA/CD	67	Aluminio
05-2799-* 05-2805-*	1W	3000K / 4000K / 5000K	60	5mm LED	12V CA/CD	67	Aluminio

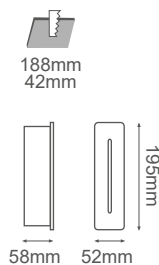

07-1276-*

-01 Blanco -03 Gris

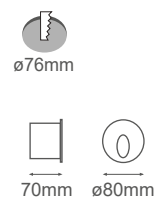
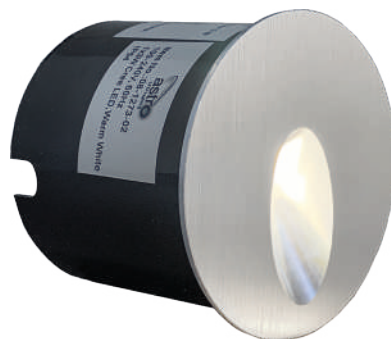

08-1273-*

-02 Satinado



08-7401-*

-08 Acero

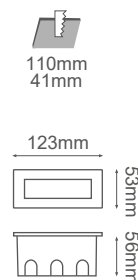

08-7501-*

-08 Acero

NOTA: Driver y Caja de Registro incluidos.

Modelo	Watts	CT	Lúmenes	LED	Voltaje	IP	Material
08-1273-*	3W	3000K	160	SMD CREE	100-240V	54	Aluminio
07-1276-*	3W	3000K	160	SMD CREE	90-240V	54	Aluminio
08-7501-*	1.5W	3000K	75	SMD	90-130V	65	Aluminio + SS316
08-7401-*	1.5W	3000K	75	SMD	90-130V	65	Aluminio + SS316

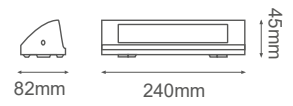

08-9002-*

-03 Gris -07 Negro

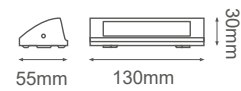
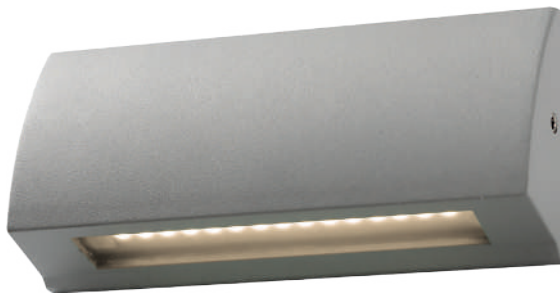

05-9001-*

-01 Blanco -03 Gris -07 Negro

NOTA: Driver incluido.

Modelo	Watts	CT	Lúmenes	LED	Voltaje	IP	Material
08-9002-*	8W	3000K	530	SMD	90-130V	54	Aluminio + Cristal
05-9001-*	3.5W	3000K	170	SMD	90-240V	54	Aluminio + Cristal

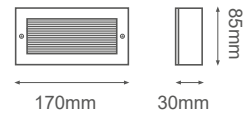
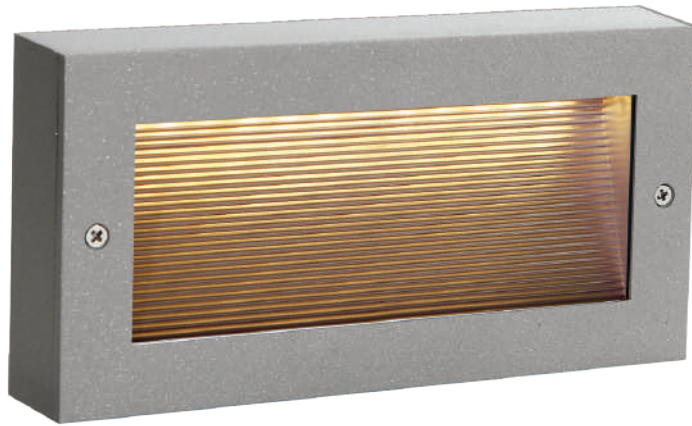
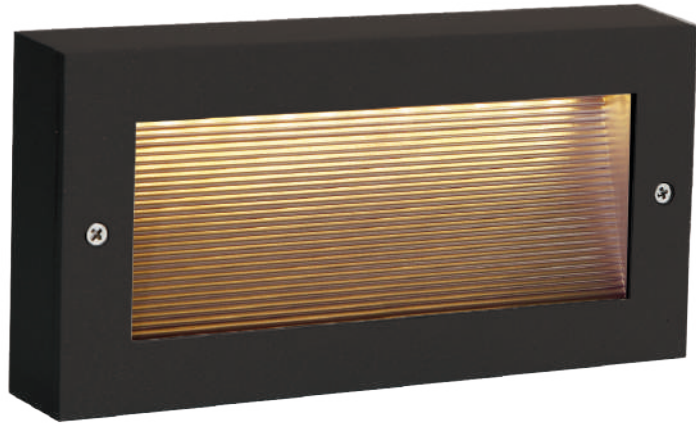

08-9245-*

-01 Blanco -03 Gris -07 Negro

NOTA: Driver incluido.

Modelo	Watts	CT	Lúmenes	LED	Voltaje	IP	Material
08-9245-*	2.6W	3000K	200	SMD	100-240V	44	Aluminio

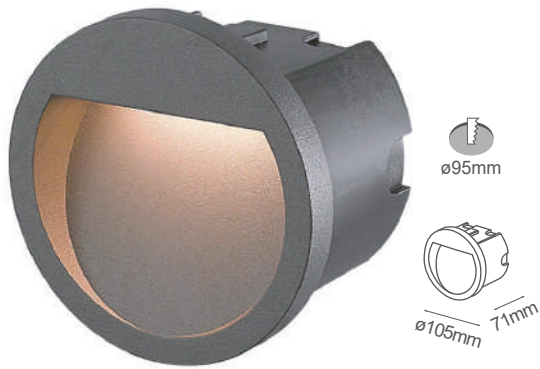

08-8301-*



- 01 Blanco
- 03 Gris
- 04 Grafito

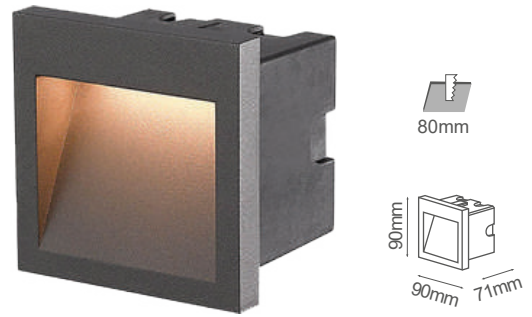

08-8401-*



- 01 Blanco
- 03 Gris
- 04 Grafito



08-8501-*



- 01 Blanco
- 03 Gris
- 04 Grafito

NOTA: Driver incluido.

Modelo	Watts	CT	Lúmenes	LED	Voltaje	IP	Material	
08-8301-*	3W	3000K	105	SMD 2835	90-130V	54	Aluminio + Cristal	
08-8401-*	3W	3000K	105	SMD 2835	90-130V	54	Aluminio + Cristal	
08-8501-*	3W	3000K	105	SMD 2835	90-130V	54	Aluminio + Cristal	

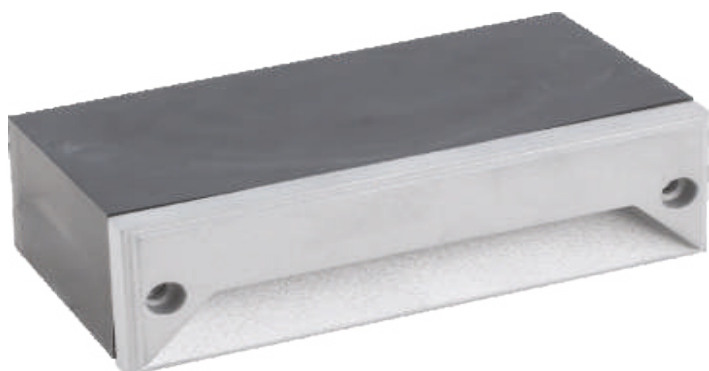

07-4201-*

-03 Gris

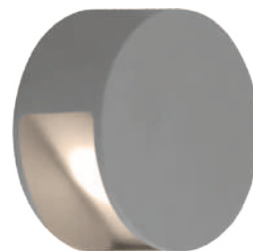
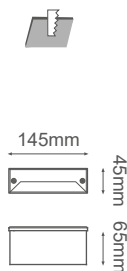

05-7001-*

-03 Gris

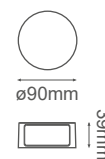

07-1280-*

-03 Gris

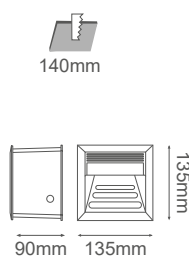

07-2702-*

-03 Gris

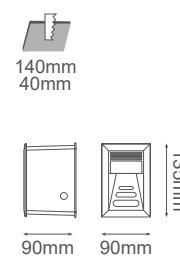

NOTA: Driver incluido.

Modelo	Watts	CT	Lúmenes	LED	Apertura	Voltaje	IP	Material
07-4201-*	1W	3000K	60	SMD	120°	110-240V	54	Aluminio + Cristal
05-7001-*	4W	3000K	320	SMD	90°	100-240V	44	Aluminio
07-1280-*	1.5W	3000K	90	SMD	-	127V	65	Aluminio
07-2702-*	1.2W	3000K	75	SMD	-	127V	65	Aluminio

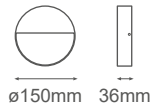

08-1901-*

-01 Blanco -04 Grafito

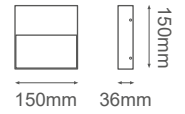

08-2201-*

-01 Blanco -04 Grafito

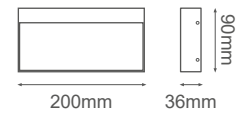

08-2203-*

-01 Blanco -04 Grafito

NOTA: Driver incluido.

Modelo	Watts	145mm CT	Lúmenes	LED	Voltaje	CRI	IP	Material
08-1901-*	6W	3000K	140	SMD	100-240V	>80	54	Aluminio
08-2201-*	6W	3000K	140	SMD	100-240V	>80	54	Aluminio
08-2203-*	6W	3000K	140	SMD	100-240V	>80	54	Aluminio

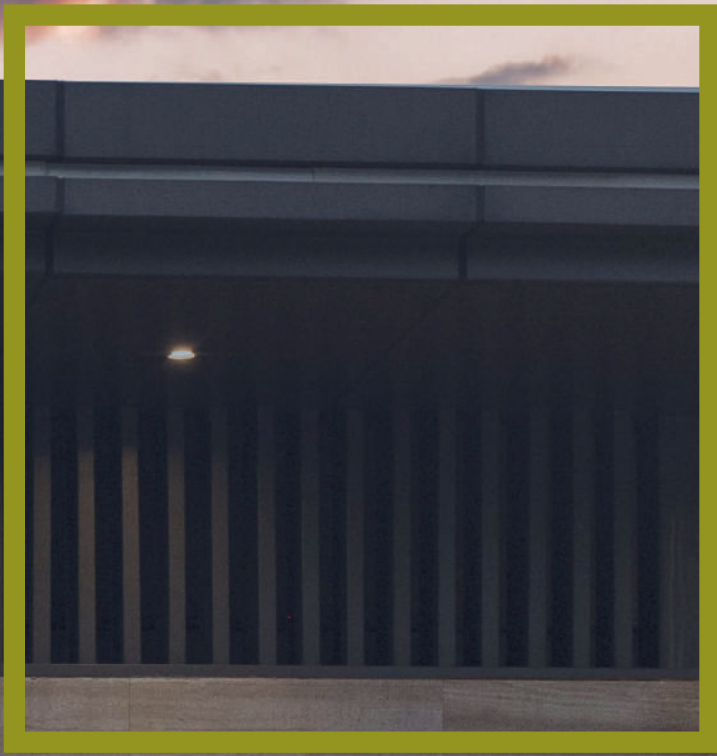

OUTDOOR PARED

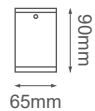

22-7161-*
"A Techo"

- 01 Blanco
- 03 Gris
- 04 Grafito

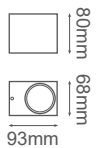

05-7493-*

- 01 Blanco
- 03 Gris
- 04 Grafito

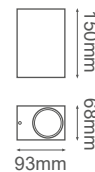

05-7494-*

- 01 Blanco
- 03 Gris
- 04 Grafito

NOTA: Focos se venden por separado.

Modelo	Base	Foco	Watts	Voltaje	IP	Material
22-7161-*	GU10	MR16	Máx. 12W	127V	44	Aluminio + Cristal Templado
05-7493-*	GU10	MR16	Máx. 12W	127V	44	Aluminio + Cristal Templado
05-7494-*	GU10	MR16	Máx. 2x12W	127V	44	Aluminio + Cristal Templado



"A Techo"



22-9051-*

-01 Blanco -03 Gris -04 Grafito

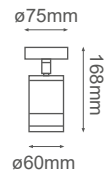

05-8054-*

-01 Blanco -03 Gris -04 Grafito

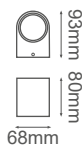
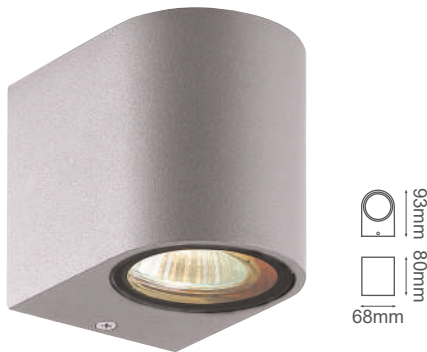

05-7491-*

-01 Blanco -03 Gris -04 Grafito

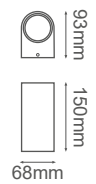

05-7492-*

-01 Blanco -03 Gris -04 Grafito

NOTA: Focos se venden por separado.

Modelo	Base	Foco	Watts	Voltaje	IP	Material
22-9051-*	GU10	MR16	Máx. 12W	130V	44	Aluminio + Cristal Templado
05-8054-*	GU10	MR16	Máx. 12W	130V	44	Aluminio + Cristal Templado
05-7491-*	GU10	MR16	Máx. 12W	130V	44	Aluminio + Cristal Templado
05-7492-*	GU10	MR16	Máx. 2x12W	130V	44	Aluminio + Cristal Templado

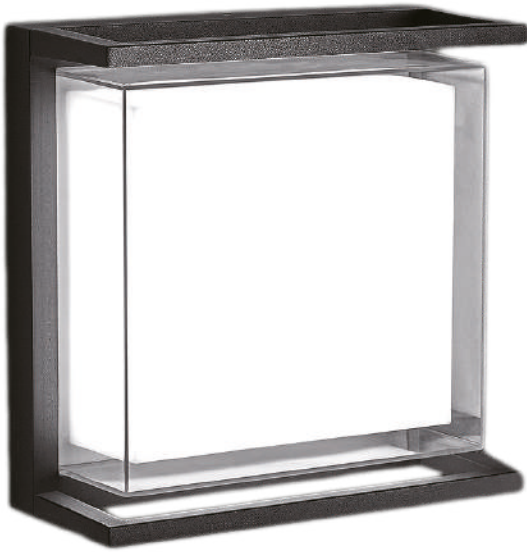

05-2143-*

-04 Grafito

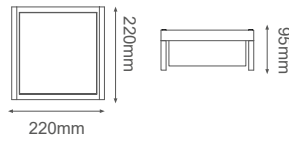

Sensor de Movimiento

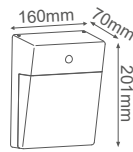

05-2921-*

-04 Grafito

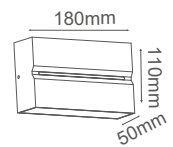
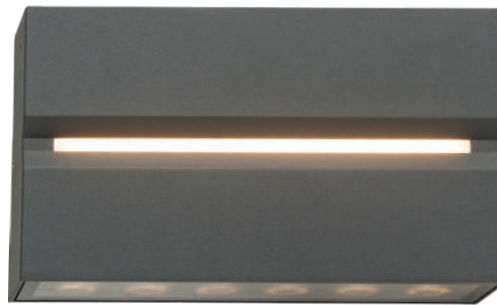

05-2091-*

-04 Grafito

NOTA: Focos se venden por separado.

Modelo	CT	Lumenes	LED	Watts	Voltaje	IP	Material
05-2143-*	3000K	1750lm	SMD	18W	100-240V	65	Aluminio + PC
05-2921-*	3000K	480lm	SMD	8W	100-240V	54	Aluminio + PC
05-2091-*	3000K	1480lm	SMD	12W	100-240V	54	Aluminio



05-7302-*

-01 Blanco -04 Grafito



05-9801-*

-03 Gris -04 Grafito

NOTA: Del modelo 05-7302-* se vende el foco por separado.

Modelo	Watts	Base	CT	Lúmenes	LED	Apertura	Voltaje	IP	Material
05-7302-*	Máx. 18W	E26	-	-	-	-	130V	44	Aluminio
05-9801-*	2x8W	-	3000K	2x490	SMD CREE	-	90-240V	54	Aluminio



22-5031-*

"A Techo"

-03 Gris -04 Grafito

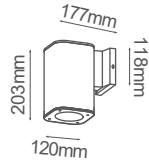

05-5031-*

-03 Gris -04 Grafito

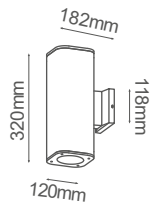

05-5032-*

-03 Gris -04 Grafito

NOTA: Focos se venden por separado.

Modelo	Base	Foco	Watts	Voltaje	IP	Material
22-5031-*	E27	PAR20	Máx.60W	120-240V	54	Aluminio + Cristal
05-5031-*	E26	PAR20	Máx.60W	120-240V	54	Aluminio + Cristal
05-5032-*	2*E26	2*PAR20	Máx. 2x60W	120-240V	54	Aluminio + Cristal



22-7133-*
"A Techo"

-01 Blanco -03 Gris -04 Grafito



05-7131-*

-01 Blanco -03 Gris -04 Grafito

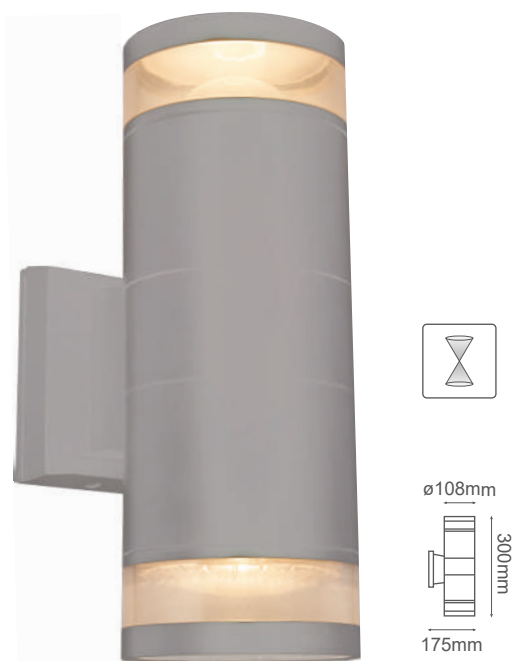

05-7132-*

-01 Blanco -03 Gris -04 Grafito



05-9006-E2

-07 Negro

NOTA: Foco PAR-20-802003 recomendado para colección EOS. Focos se venden por separado.
05-7131-* intercambiable por foco PAR-30-30-0412. Se vende por separado

Modelo	Base	Foco	Watts	Voltaje	IP	Material
22-7133-*	E26	A19 / PAR30	Máx. 60W	130V	44	Aluminio + Cristal Templado
05-7131-*	E26	A19 / PAR30	Máx. 60W	130V	44	Aluminio + Cristal Templado
05-7132-*	E26	A19 / PAR20	Máx. 2x60W	130V	44	Aluminio + Cristal Templado
05-9006-E2	2xE26	2xA19	Máx. 2x60W	130V	44	Plástico



"A Techo"

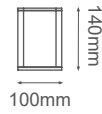

22-2073-*

-03 Gris

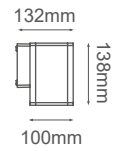

05-2071-*

-03 Gris

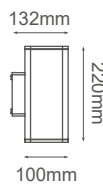

05-2072-*

-03 Gris

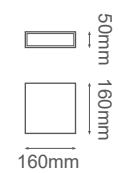

05-1018-*

-03 Gris -04 Grafito

Modelo	Watts	CT	Lúmenes	LED	Apertura	Voltaje	IP	Material
22-2073-*	12W	3000K	870	CREE COB	46°	100-240V	54	Aluminio
05-2071-*	12W	3000K	870	CREE COB	46°	100-240V	54	Aluminio
05-2072-*	2x12W	3000K	870	CREE COB	46°	100-240V	54	Aluminio
05-1018-*	2x8W	3000K	2x560	SMD 2835	-	127V	65	Aluminio + Cristal

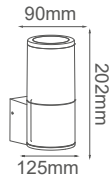

05-2101-*

-04 Grafito

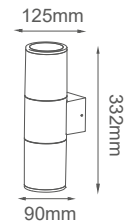

05-2102-*

-04 Grafito



05-2509-*

-03 Gris

NOTA: Focos se venden por separado.

Modelo	Base	Foco	Watts	Voltaje	IP	Material
05-2101-*	E27	G45	Máx.25W	120V	54	Aluminio
05-2102-*	E27	G45	Máx.25W	120V	54	Aluminio

Modelo	Watts	CT	Lúmenes	LED	Apertura	Voltaje	IP	Material
05-2509-*	9W	3000K	400	SMD	-	90-130V	65	Aluminio

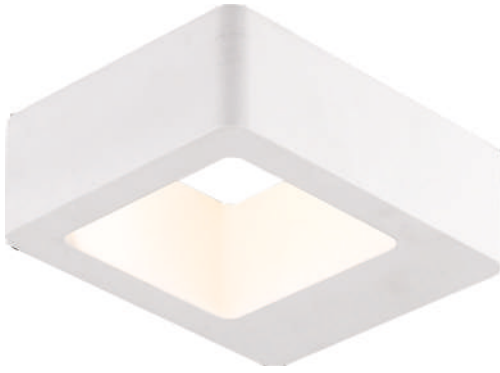

05-2701-*
 -01 Blanco -04 Grafito
 45mm 145mm 120mm



05-8107-*
 -01 Blanco -04 Grafito
 28mm ø113mm 90mm



05-8108-*
 -01 Blanco -04 Grafito
 28mm ø175mm 90mm

Modelo	Watts	CT	Lúmenes	LED	Apertura	Voltaje	IP	Material
05-2701-*	7W	3000K	360	SMD CREE	92°	100-240V	54	Aluminio + PC
05-8107-*	8W	3000K	640	SMD EPISTAR	-	90-240V	65	Aluminio +PC
05-8108-*	12W	3000K	960	SMD EPISTAR	-	90-240V	65	Aluminio +PC



05-3223-*

-07 Negro

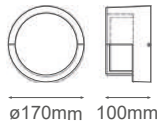

05-2271-*

-04 Grafito

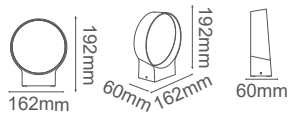

05-2616-*

-05 Bronce Rust

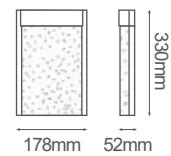

Modelo	Watts	CT	Lúmenes	LED	Voltaje	CRI	IP	Material
05-3223-*	8W	3000K	450	PCB	127V	>80	54	Aluminio + Acrílico
05-2616-*	9W	3000K	400	PCB	127V	>80	54	Aluminio + Cristal
05-2271-*	12W	3000K	1260	-	100-240V	>-	54	Aluminio

URANO



05-0093-*

-07 Negro

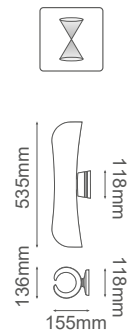

05-0094-*

-07 Negro

Modelo	Base	Foco	Watts	CT	LED	Lúmenes	Voltaje	IP	Material
05-0093-*	2*GU10	2*MR16	Máx. 2*12W	-	-	-	110-240V	54	Aluminio
Modelo	Watts	CT	Lúmenes	LED	Voltaje	CRI	IP	Material	
05-0094-*	2*11W	3000K	2*770lm	SMD2835	100-240V	>80	65	Aluminio	

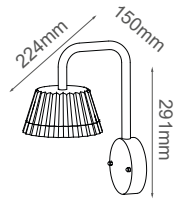

05-2121-*

-04 Grafito

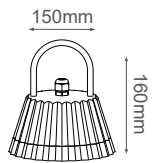

23-2123

-04 Grafito

Modelo	Watts	CT	Lúmenes	LED	Voltaje	CRI	IP	Material
05-2121-*	10W	3000K	400lm	SMD2835	100-240V	>80	65	Aluminio
23-2123-*	10W	3000K	400lm	SMD2835	100-240V	>80	65	Aluminio

CLIO

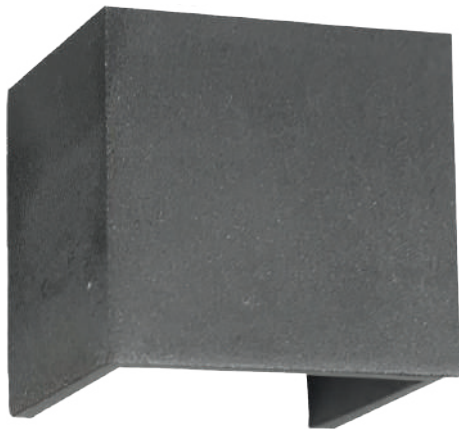

05-7510-*

-11 Concreto

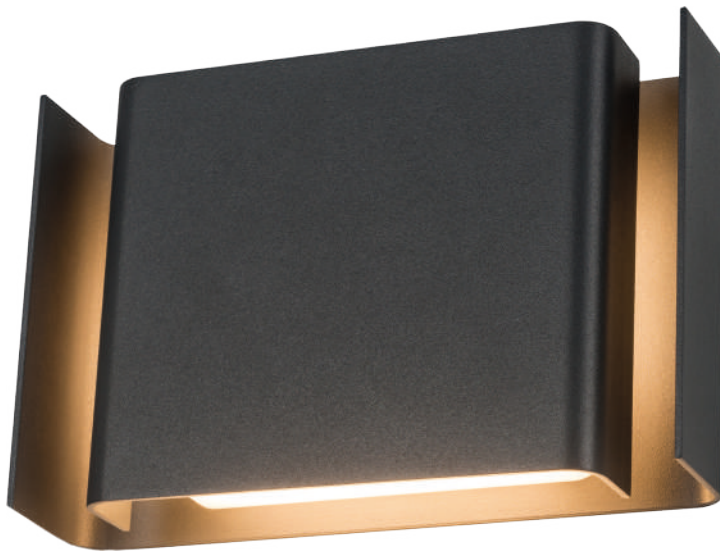
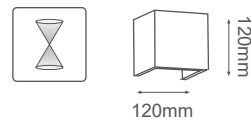

05-2061-*

-01 Blanco -04 Grafito

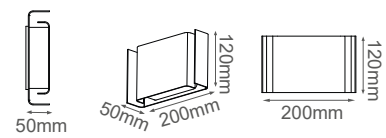

Modelo	Watts	CT	Lúmenes	LED	Voltaje	CRI	IP	Material
05-7510-*	10W	3000K	900	PHILIPS	110-277V	>80	54	Concreto + Alum
05-2061-*	12W	3000K	960	SMD	100-240V	-	54	Concreto + Alum



05-2942-*

-04 Grafito

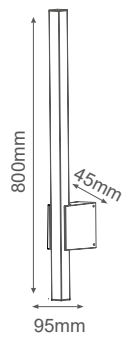

05-2678-*

-07 Negro

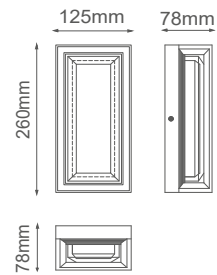

05-6410-*

-09 ABZ

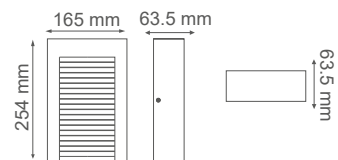

Modelo	Watts	CT	Lúmenes	LED	Voltaje	CRI	IP	Material
05-2678-*	12W	3000K	960	-	110V	>-	54	Aluminio
05-2942-*	12W	3000K	1260	-	100-240V	>-	54	Aluminio
05-6410-*	18W	3000K	1440	-	120V	>-	54	Aluminio



05-6216-*

-04 Grafito

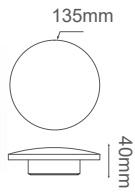

05-1001-*

-01 Blanco -04 Grafito

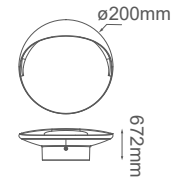

05-8238-*

-04 Grafito

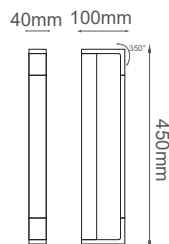

05-4820-*

-07 Negro

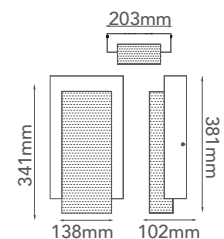

Modelo	Watts	CT	Lúmenes	LED	Voltaje	CRI	IP	Material
05-6216	6W	3000K	540lm	-	120V	>-	54	Aluminio
05-1001	7W	3000K/4000K/6000K	280lm	-	-	>80	65	Aluminio
05-4820	15W	3000K	1200lm	-	120V	>-	54	Aluminio + Acrílico
05-8238	12W	3000K	960lm	-	120V	>-	44	Aluminio

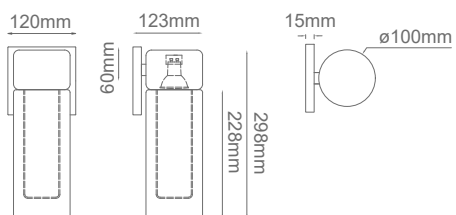

05-1241-*

-09 ABZ

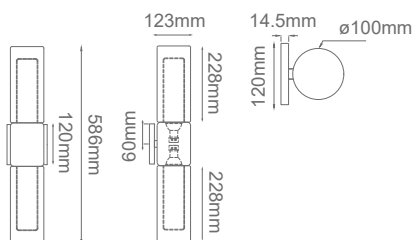

05-1248-*

-09 ABZ

Modelo	Base	Foco	Watts	Voltaje	IP	Material
05-1241	GU10	MR16	Máx. 12W	120V	54	Aluminio + Glass
05-1248	GU10	MR16	Máx. 12W	120V	54	Aluminio + Glass



OUTDOOR PISO



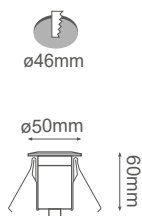
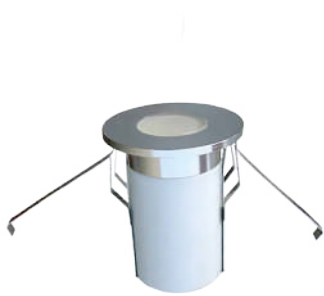

07-1701-*

-02 Satinado

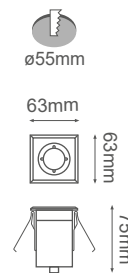

07-1703-*

-02 Satinado

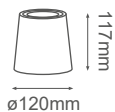

07-7053-*

-11 Concreto



07-9201-*

-08 Acero

Modelo	Watts	CT	Lúmenes	LED	Apertura	Voltaje	CRI	IP	Material
07-1701-*	.5W	3000K / 4000K / 5000K	30	5mm LED	45°	127V	>80	67	Aluminio + Cristal
07-1703-*	.5W	3000K	30	5mm LED	58°	127V	>80	67	Aluminio + Cristal

NOTA: Foco se vende por separado.

Modelo	Base	Foco	Watts	Voltaje	IP	Material
07-7053-*	GU10	MR16	Máx.12W	110-240V	65	Concreto + Cristal
07-9201-*	GU10	MR16	Máx.12W	127V	65	Tapa de SS316



07-0301-*

-08 Acero



07-30100-*

-08 Acero



07-1015-08-*

-08 Acero



07-62100-*

-08 Acero

Modelo	Watts	CT	Lúmenes	LED	Apertura	Voltaje	CRI	IP	Material
07-0301-*	3W	3000K / 4000K	300	SMD CREE	45°	100-240V	>	65	Tapa de SS316
07-30100-*	3W	3000K	177	SMD bridgelux	45°	100-240V	>	67	Tapa de SS316
07-62100-*	1W	3000K	62	SMD bridgelux	45°	100-240V	>	67	Tapa de SS316
07-1015-08-*	1W	3000K	70	SMD	30°	110V AC	>80	67	Acero inoxidable



07-1011-*

-08 Acero



07-1012-*

-08 Acero



07-1014-*

-08 Acero

Modelo	Watts	CT	Lúmenes	LED	Apertura	Voltaje	CRI	IP	Material
07-1011-	1W	3000K	70lm	SMD	100°	110V AC	>80	67	Acero inoxidable
07-1012-	1W	3000K	70lm	SMD	100°	110V AC	>80	67	Acero inoxidable
07-1014-	1W	3000K	70lm	SMD	80°	110V AC	>80	67	Acero inoxidable

OCTOPUS II

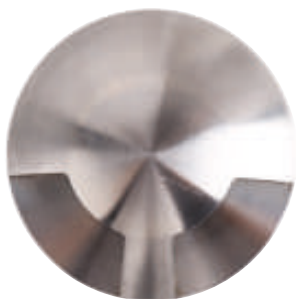

07-40921-*

-08 Acero



ø92mm



25mm



ø86mm

07-40922-*

-08 Acero



ø92mm



25mm



ø86mm

07-40926-*

-08 Acero



ø92mm



25mm



ø86mm

Modelo	Watts	CT	Lúmenes	LED	Voltaje	CRI	IP	Material
07-40921-*	3W	3000K	270	SMD EPISTAR	100-240V	>80	67	Acero SS316
07-40922-*	3W	3000K	300	SMD EPISTAR	100-240V	>80	67	Acero SS316
07-40926-*	3W	3000K	330	SMD EPISTAR	100-240V	>80	67	Acero SS316

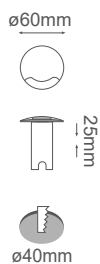

07-0061-*

Soporta paso vehicular de hasta 2 toneladas.

-03 Gris



07-0062-*

Soporta paso vehicular de hasta 2 toneladas.

-03 Gris

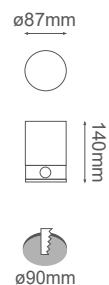

07-2721-*

*Housing Acero

Modelo	Watts	CT	Lúmenes	LED	Apertura	Voltaje	IP	Material
07-0061-*	2.4W	3000K / 4000K	65	CREE SMD	-	24V DC	65	Tapa de SS316
07-0062-*	2.4W	3000K / 4000K	192	CREE SMD	-	24V DC	65	Tapa de SS316
07-2721-*	3W	3000K / 4000K	180	CREE SMD	120°	220-240V AC	67	Alum + Cristal Templ.



07-6201-*

-08 Acero



ø120mm

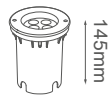

07-6301-*

-08 Acero



ø140mm

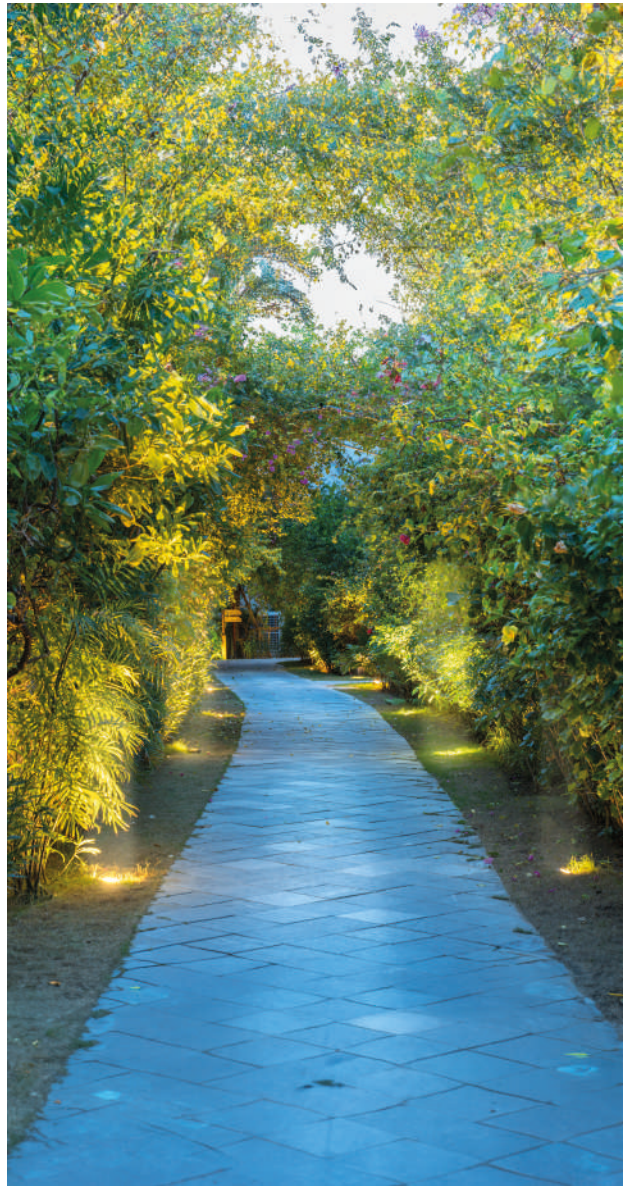
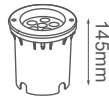

Modelo	Watts	CT	Lúmenes	LED	Apertura	Voltaje	CRI	IP	IK	Material
07-6201-10-*	9W	3000K	850	CREE SMD	20°	100-240V	>80	67	10	Tapa de SS316
	9W	4000K	900	CREE SMD	20°	100-240V	>80	67	10	Tapa de SS316
07-6201-*	9W	3000K	850	CREE SMD	45°	100-240V	>80	67	10	Tapa de SS316
	9W	4000K	900	CREE SMD	45°	100-240V	>80	67	10	Tapa de SS316

Modelo	Watts	CT	Lúmenes	LED	Apertura	Voltaje	CRI	IP	IK	Material
07-6301-10-*	12W	3000K	1083	CREE SMD	20°	100-240V	>80	67	10	Tapa de SS316
	12W	4000K	1140	CREE SMD	20°	100-240V	>80	67	10	Tapa de SS316
07-6301-*	12W	3000K	1083	CREE SMD	45°	100-240V	>80	67	10	Tapa de SS316
	12W	4000K	1140	CREE SMD	45°	100-240V	>80	67	10	Tapa de SS316



ø180mm

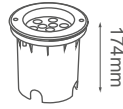

ø141mm

07-6401-*

-08 Acero



ø250mm

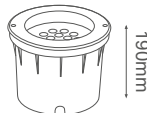

ø202mm

07-7301-*

-08 Acero

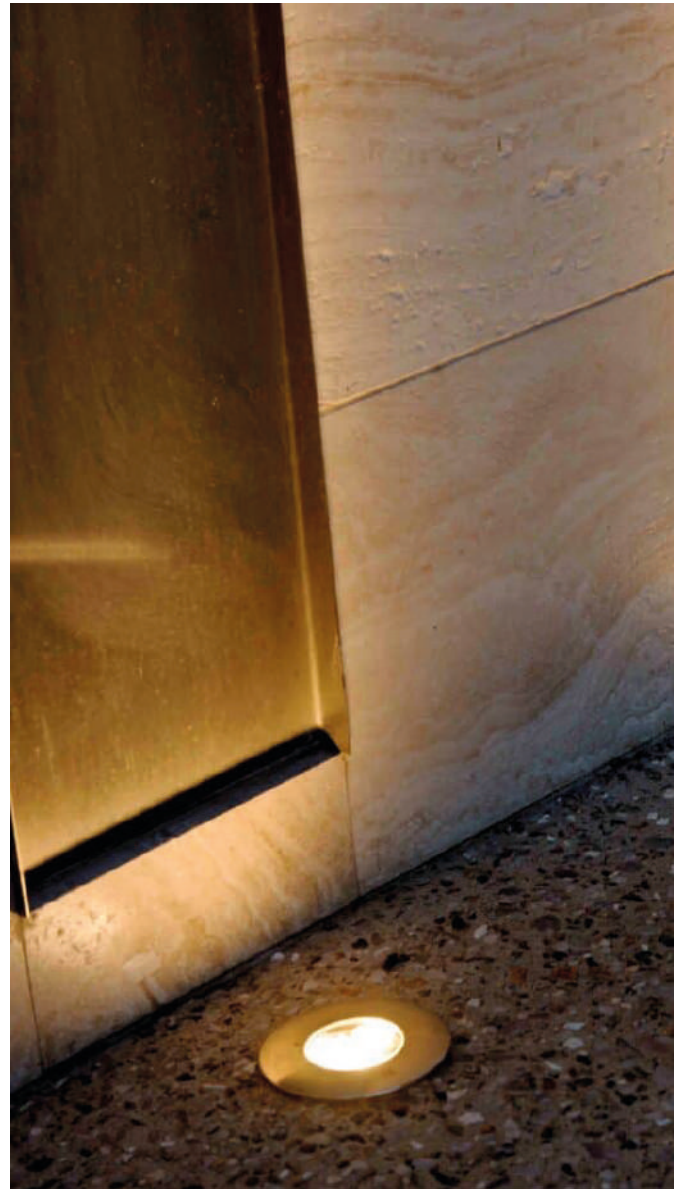

ATLANTIC

Modelo	Watts	CT	Lúmenes	LED	Apertura	Voltaje	CRI	IP	IK	Material
07-6401-10-*	18W	3000K	1625	CREE SMD	20°	100-240V	>80	67	10	Tapa de SS316
	18W	4000K	1710	CREE SMD	20°	100-240V	>80	67	10	Tapa de SS316
07-6401-*	18W	3000K	1625	CREE SMD	45°	100-240V	>80	67	10	Tapa de SS316
	18W	4000K	1710	CREE SMD	45°	100-240V	>80	67	10	Tapa de SS316

Modelo	Watts	CT	Lúmenes	LED	Apertura	Voltaje	CRI	IP	IK	Material
07-7301-*	36W	3000K / 4000K	3600	CREE SMD	20° / 45°	100-240V	>80	67	10	Tapa de SS316



07-30011-*

07-30012-*

07-30016-*

-03 Gris

-03 Gris

-03 Gris

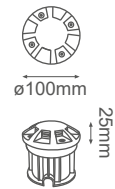
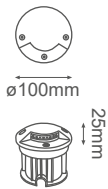

Modelo	Watts	CT	Lúmenes	LED	Voltaje	CRI	IP	Material
07-30011-*	3W	3000K	270	SMD	100-240V	>80	67	Aluminio
07-30012-*	3W	3000K	300	SMD	100-240V	>80	67	Aluminio
07-30016-*	3W	3000K	330	SMD	100-240V	>80	67	Aluminio



07-07300-*

-08 Acero

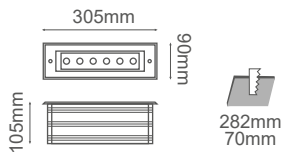

97-06300-*

-08 Acero

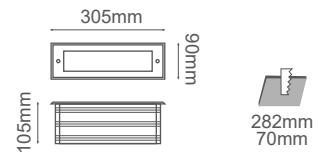

07-07601-*

-08 Acero

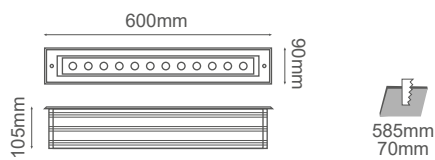

97-06601-*

-08 Acero

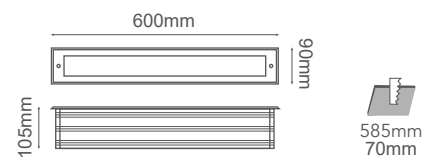

Modelo	Watts	CT	Lúmenes	LED	Apertura	Voltaje	IP	Material
07-07300-*	6W	3000K	600	SMD <u>bridgelux</u>	45°	100-240V	67	Aluminio + SS316
97-06300-*	6W	3000K	600	SMD <u>bridgelux</u>	120°	100-240V	67	Aluminio + SS316
07-07601-*	12W	3000K	1200	SMD <u>bridgelux</u>	45°	100-240V	67	Aluminio + SS316
97-06601-*	12W	3000K	1200	SMD <u>bridgelux</u>	120°	100-240V	67	Aluminio + SS316



SPIKE LIGHTS



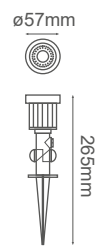

05-3505-CW

-07 Negro

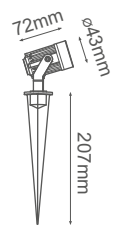

05-9105-*

-07 Negro

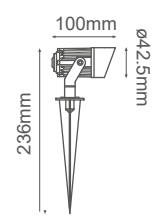

05-9205-*

-07 Negro

NOTA: Driver y estaca incluidos.

Modelo	Watts	CT	Lúmenes	LED	Apertura	Voltaje	CRI	IP	Material
05-3505-CW	5W	6500K	400	SMD	38°	100-240V	>80	65	Plástico
05-9105-*	5W	3000K / 4000K / 6000K	450	COB EPISTAR	30°	90-130V	>80	65	Aluminio
05-9205-*	5W	3000K / 6000K	450	COB EPISTAR	30°	90-130V	>80	65	Aluminio



03-4801-*

-04 Grafito

*Foco se vende por separado



05-9106-*

-04 Grafito



CAP-05-9106

*Se vende por separado



03-4901-*

-04 Grafito

NOTA: Driver y estaca incluidos.

Modelo	Watts	Base	Foco	CT	Lúmenes	LED	Apertura	Voltaje	CRI	IP	Material
03-4801-*	Máx. 12W	GU10	MR16	-	-	-	-	127V	-	65	Alum + Cristal
05-9106-*	10W	-	-	3000K / 4000K	800	bridgeled COB	38°	100-240V AC	>80	65	Alum + Cristal
03-4901-*	6W	-	-	3000K / 4000K	420	SMD	45°	100-130VAC	>80	65	Alum + Acrílico

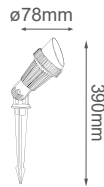

03-9005-GU-*

-07 Negro

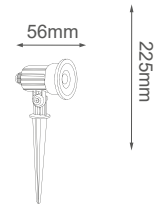

03-9003-WW-*

-07 Negro

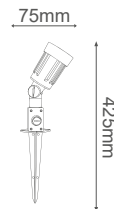

03-9101-E2-*

-07 Negro

NOTA: Driver y Estaca incluidos.

Modelo	Watts	Base	Foco	CT	Lúmenes	LED	Apertura	Voltaje	CRI	IP	Material
03-9005-GU-*	Máx. 7W	GU10	MR16	-	-	-	-	110V	-	54	PC
03-9101-E2-*	Máx. 7W	E27	A19	-	-	-	-	110V	-	44	PC
03-9003-WW-*	5W	-	-	2700K	400lm	-	38°	100-240VAC	80	65	PC

NOON



10-2351-*

-04 Grafito

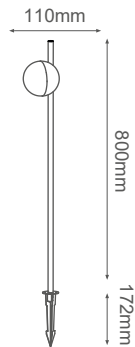

10-2352-*

-04 Grafito

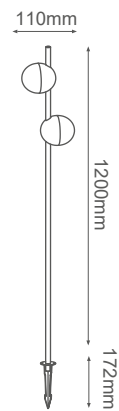

NOTA: Driver y Estaca incluidos.

Modelo	Watts	CT	Lúmenes	LED	Apertura	Voltaje	CRI	IP	Material
10-2351-*	6W	2700K	480lm	-	-	100-240V	-	65	Aluminio
10-2352-*	12W	2700K	960lm	-	-	100-240V	-	65	Aluminio

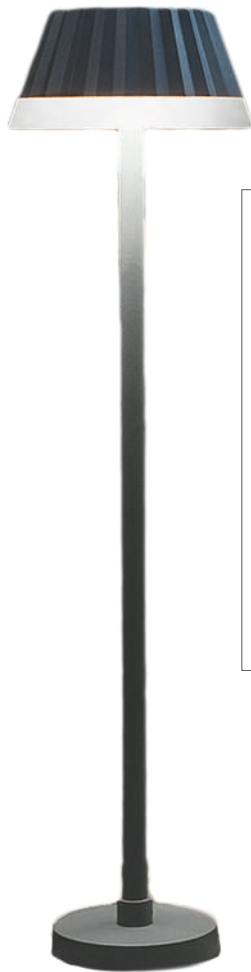

10-2122-*

-04 Grafito

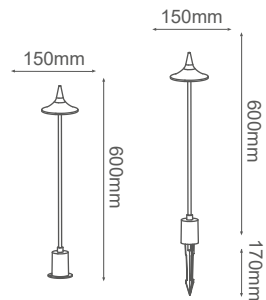

10-2942-*

-04 Grafito

NOTA: Driver, Base y Estaca incluidos.

Modelo	Watts	CT	Lúmenes	LED	Apertura	Voltaje	CRI	IP	Material
10-2122-*	10W	3000K	950	-	-	100-240V	-	65	Aluminio
10-2942-*	6W	3000K	480	-	-	100-240V	-	65	Aluminio

A modern outdoor pool area at dusk. The pool is illuminated with blue lights, and the surrounding patio is lit with warm yellow lights. A pergola structure covers the patio area, and there are lounge chairs and a dining table. The sky is a deep blue, and a large, empty square frame is visible in the upper right portion of the image.

SUBÁCUATICAS



77-2501-*

Ø8 Acero

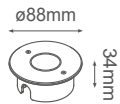

77-2503-*

Ø8 Acero

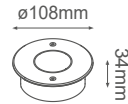

77-2506-*

Ø8 Acero

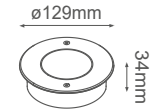

NOTA: Requieren transformador 24VCD. Además deben trabajar siempre sumergidos en agua.

Modelo	Watts	CT	Lúmenes	LED	Apertura	Voltaje	CRI	IP	Material
77-2501-*	3.9W	3000K / 5000K	165	CREE XP	12.5°	24V DC	>80	68	SS316
77-2503-*	8.3W	3000K / 5000K	420	CREE XP	12.6°	24V DC	>80	68	SS316
77-2506-*	14.3W	3000K / 5000K	793	CREE XP	12.9°	24V DC	>80	68	SS316



*Housing Incluido



77-4703-* Cable 5m.

-08 Acero

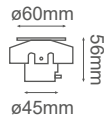

07-1707-*

-02 Satinado

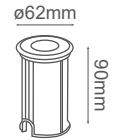

07-62024-*

-08 Acero

NOTA: Requieren transformador. Además deben trabajar siempre sumergidos en agua.

Modelo	Watts	CT	Lúmenes	LED	Apertura	Voltaje	CRI	IP	Material
77-4703-*	12W	3000K / 4000K / 5000K	960	SMD	15°	24V CD	>80	68	SS316
07-1707-*	1W	3000K	62	SMD <i>bridgelux.</i>	45°	12V CD/CA	>80	68	Aluminio
07-62024-*	1W	3000K	62	SMD <i>bridgelux.</i>	45°	24V CD	>80	68	Aluminio + SS316

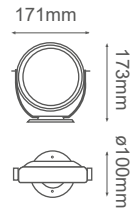

05-7021-*

-03 Gris

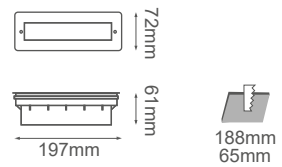



07-0455-*

-08 Acero

*Incluye Transformador 12V.

NOTA: Requieren transformador. Además deben trabajar siempre sumergidos en agua.

Modelo	Watts	CT	Lúmenes	LED	Apertura	Voltaje	CRI	IP	Material
05-7021-*	30W	4000K	2700	SMD	15°	24V CD	>80	68	Acero SS316 
07-0455-*	3.2W	3000K / 4000K	156	SMD CREE	-	127 / 12V	>80	68	Acero SS316 

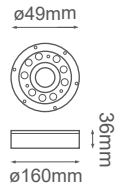

77-0391-*

-08 Acero

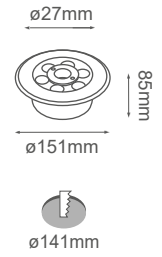

77-0306-DW

-08 Acero



NOTA: Requieren transformador 24VCD. Además deben trabajar siempre sumergidos en agua.

Modelo	Watts	CT	Lúmenes	LED	Apertura	Voltaje	CRI	IP	Material
77-0391-*	13.5W	3000K / 5000K	720	SMD CREE	45°	24V CD	>80	68	Acero SS316 
77-0306-DW	6W	5000K	420	SMD bridgelux	45°	24V CD	>80	68	Acero SS304 



BALIZAS

CAGE

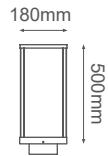

10-1932-*

-05 Bronce Rust

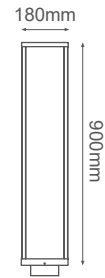

55-1933-*

-05 Bronce Rust

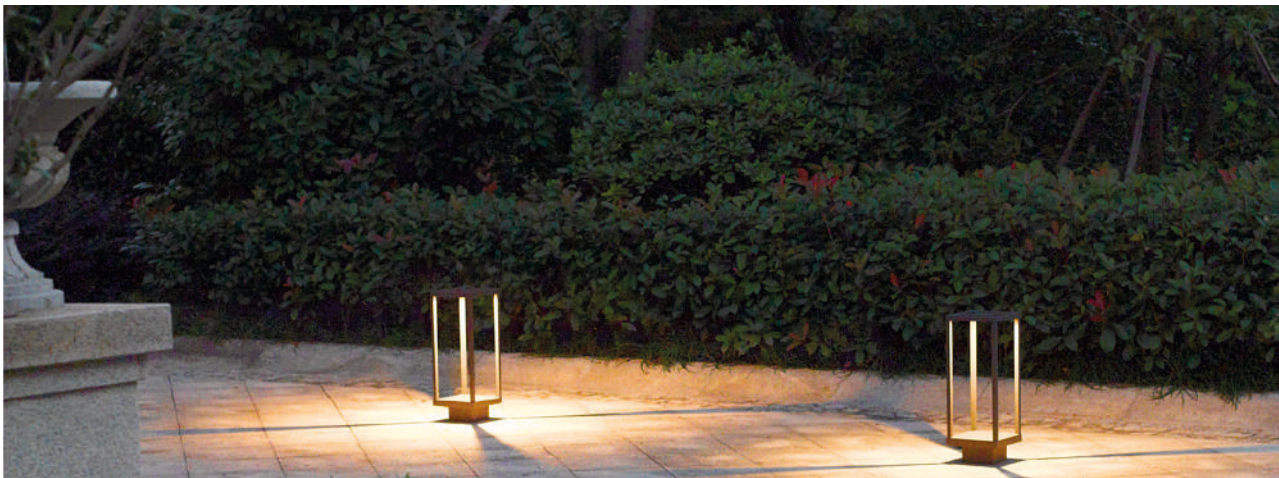

Modelo	Watts	CT	Lúmenes	LED	Apertura	Voltaje	CRI	IP	Material
10-1932-*	12W	3000K	700	SMD CREE	125°	100-240V	>80	54	Aluminio
55-1933-*	12W	3000K	700	SMD CREE	125°	100-240V	>80	54	Aluminio

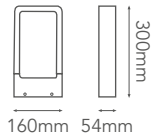

10-2704-*
-04 Grafito



*Orión versión muro disponible

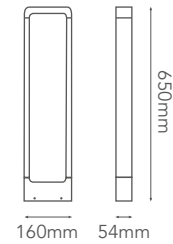

55-2704-*
-04 Grafito



55-9107-*
-03 Gris

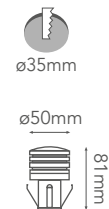

10-1071-*
-03 Gris

Modelo	Watts	CT	Lúmenes	LED	Apertura	Voltaje	CRI	IP	Material
10-2704-*	7W	3000K	630lm	SMD bridgelux	-	100-240V	>80	IP55 / Driver IP65	Aluminio
55-2704-*	7W	3000K	630lm	SMD bridgelux	-	100-240V	>80	IP55 / Driver IP65	Aluminio
10-1071-*	1W	6000K	60	SMD CREE	-	100-240V	>80	67	Aluminio
55-9107-*	3W	4000K	330	SMD CREE	-	100-240V	>80	54	Aluminio

POLARIS

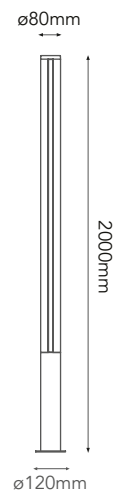

55-2091-WW

-04 Grafito

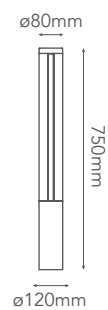

10-2091-WW

-04 Grafito

Modelo	Watts	CT	Lúmenes	LED	Apertura	Voltaje	CRI	IP	Material
55-2091-WW	27W	3000K	1290	SMD	112°	100-240V	>80	IP55 / Driver IP65	Aluminio
10-2091-WW	9W	3000K	500	SMD	112°	100-240V	>80	IP55 / Driver IP65	Aluminio



55-2773-*

-04 Grafito

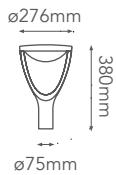

55-2775-*

-04 Grafito



Modelo	Watts	CT	Lúmenes	LED	Apertura	Voltaje	IP	Material
55-2773-*	22W	3000K	1850	SMD 2835	144°	100-240V	65	Aluminio + PC
55-2775-*	22W	3000K	1850	SMD 2835	144°	100-240V	65	Aluminio + PC

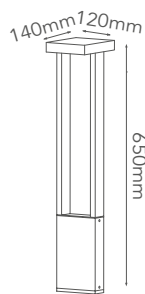

10-2522-*

-07 Negro



10-2103-*

-04 Grafito

Modelo	Watts	CT	Lúmenes	LED	Apertura	Voltaje	IP	Material
10-2522-*	14W	3000K	1120	-	-	100-240V	68	Aluminio

NOTA: Foco se vende por separado.

Modelo	Base	Watts	Voltaje	IP	Material
10-2103-*	E27	Máx.25W	127	54	Aluminio



REFLECTORES





90-3001-*

-03 Gris

*Requiere Fuente de Poder.

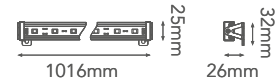

90-3201-WW

-03 Gris

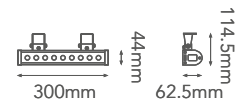

90-3202-*

-03 Gris

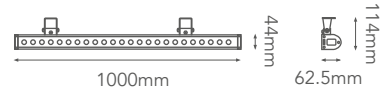

90-2943-*

-04 Grafito

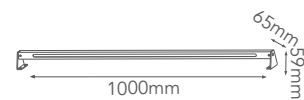

Modelo	Watts	CT	LED	Lúmenes	Apertura	Voltaje	CRI	IP	Material
90-3001-*	11.5W	3000K / 4000K	SMD	700	120°	24V CD	>80	67	Aluminio
90-3201-WW	9W	3000K	SMD	900	25°x45°	100-240V	>80	65	Aluminio + Cristal Templado
90-3202-*	24W	3000K / 4000K	SMD CREE	2100	45°	100-240V	>80	65	Aluminio + Cristal Templado
90-2943-*	15W	3000K	SMD	1500	-	100-240V	>80	65	Aluminio + Cristal Templado



05-0010-*

-07 Negro

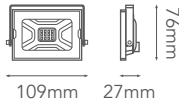

76mm



05-0020-*

-07 Negro

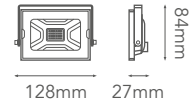

84mm



05-0030-*

-07 Negro

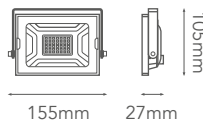

105mm

NOTA: Driver incluido, 50cm de Cable.

Modelo	Watts	CT	Lúmenes	LED	Apertura	Voltaje	CRI	PF	IP	Material
05-0010-*	10W	3000K / 6000K	800	SMD	120°	90-260V	>80	0.9	65	Aluminio
05-0020-*	20W	3000K / 6000K	1600	SMD	120°	85-265V	>80	0.9	65	Aluminio
05-0030-*	30W	3000K / 6000K	2400	SMD	120°	85-265V	>80	0.9	65	Aluminio



05-0050-*

-07 Negro



208mm



27mm

141mm



5-25100-*

-07 Negro



292mm



40mm

192mm



5-25400-WW

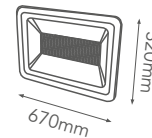

670mm

320mm

NOTA: Driver incluido, 50cm de Cable.

Modelo	Watts	CT	Lúmenes	LED	Apertura	Voltaje	CRI	PF	IP	Material
05-0050-*	50W	3000K / 5000K	4000	SMD	120°	85-265V	>80	0.9	65	Aluminio
5-25100-*	100W	3000K / 5000K	8000	SMD	120°	110-130V	>80	0.9	65	Aluminio
5-25400-WW	400W	3000K	30000	SMD	120°	85-265V	>80	0.9	65	Aluminio



5-25250-DW

-07 Negro

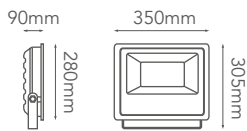

05-3500-DW

-07 Negro

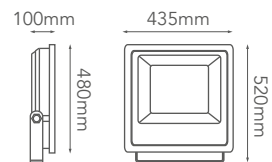

Modelo	Watts	CT	Lúmenes	LED	Apertura	Voltaje	CRI	PF	IP	Material
5-25250-DW	250W	5000K	20000	SMD	120°	85-265V	>80	0.9	65	Aluminio + Cristal
05-3500-DW	500W	5000K	45000	SMD	120°	85-265V	>80	0.9	65	Aluminio + Cristal



5-21101-NW

-03 Gris

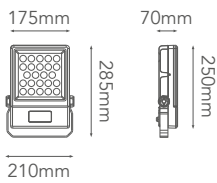

5-21201-NW

-03 Gris

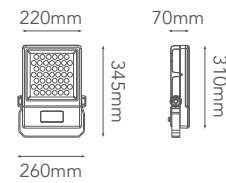

5-21301-NW

-03 Gris

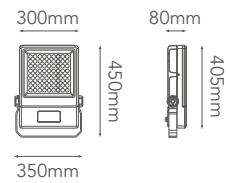

Modelo	Watts	CT	Lúmenes	LED	Apertura	Voltaje	CRI	IP	Material
5-21101-NW	50W	4100K	6000	SMD 3737	30°	100-240V AC	>80	65	Aluminio
5-21201-NW	100W	4100K	12000	SMD 3737	30°	100-240V AC	>80	65	Aluminio
5-21301-NW	150W	4100K	18000	SMD 3737	30°	100-240V AC	>80	65	Aluminio



SISTEMAS DE RGB



6-26752-RGB

-01 Blanco



07-1701-RGB

-02 Satinado

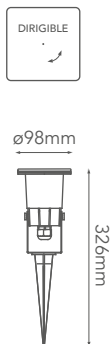

05-0901-RGB

*Estaca se vende por separado

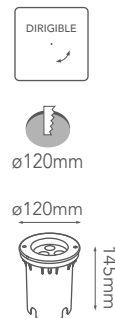

07-0301-RGB

-08 Acero

NOTA: Controlador y Fuente de Poder se venden por separado.

Modelo	Watts	CT	LED	Apertura	Voltaje	IP	Material
6-26752-RGB	9W	RGB	COB	38°	12V CD	20	Aluminio
07-1701-RGB	1.5W	RGB	SMD	45°	12V CD	68	Aluminio + SS316
05-0901-RGB	3W	RGB	SMD CREE	45°	12V CD	67	Aluminio
07-0301-RGB	6W	RGB	SMD CREE	45°	12V CD	67	Tapa de SS316

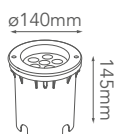

07-6301-RGB

-08 Acero

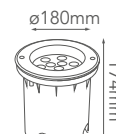

07-6401-RGB

-08 Acero

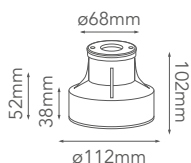

77-6013-RGB

-08 Acero

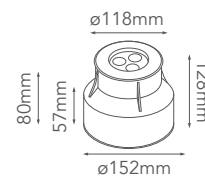

77-6015-RGB

-08 Acero



NOTA: Controlador y Fuente de Poder se venden por separado.

Modelo	Watts	CT	LED	Apertura	Voltaje	IP	IK	Material
07-6301-RGB	12W	RGB	SMD 3737	45°	12V CD	67	10	Tapa de SS316
07-6401-RGB	18W	RGB	SMD 3737	45°	12V CD	10	67	Tapa de SS316
77-6013-RGB	3W	RGB	CREE SMD	60°	24V DC	68		Tapa de SS316
77-6015-RGB	5W	RGB	CREE SMD	60°	24V DC	68		Tapa de SS316

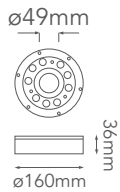

Cable 5m.

77-0393-RGB

-08 Acero



Housing incluido



77-4703-RGB

-08 Acero

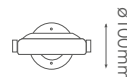

05-7021-RGB

-03 Gris

NOTA: Requieren Controlador y Fuente de Poder.

Modelo	Watts	CT	LED	Apertura	Voltaje	CRI	IP	Material
77-0393-RGB	31.5W	RGB	CREE SMD	45°	24V CD	>80	68	SS316
77-4703-RGB	17W	RGB	CREE SMD	15°	24V CD	>80	68	SS316
05-7021-RGB	30W	RGB	CREE SMD	15°	24V CD	>80	68	SS316

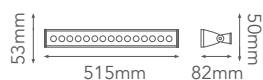

05-0502-RGB

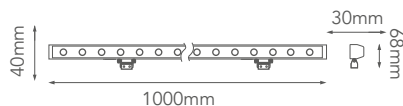
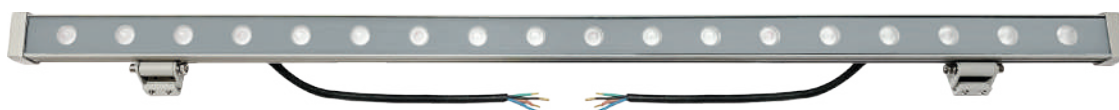

90-2501-RGB

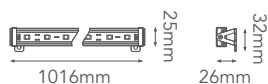

90-3001-RGB

NOTA: Controlador y Fuente de Poder se venden por separado.

Modelo	Watts	CT	LED	Apertura	Voltaje	CRI	IP	Material
05-0502-RGB	20W	RGB	CREE SMD	45°x25°	24V CD	>80	65	Aluminio
90-2501-RGB	32W	RGB	CREE SMD	45°	24V CD	>80	65	Aluminio
90-3001-RGB	11.5W	RGB	CREE SMD	120°	24V CD	>80	67	Aluminio

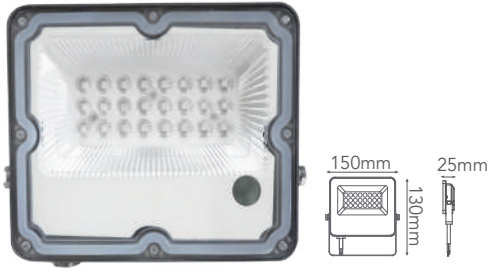

5-3620-RGB-*

-03 Gris

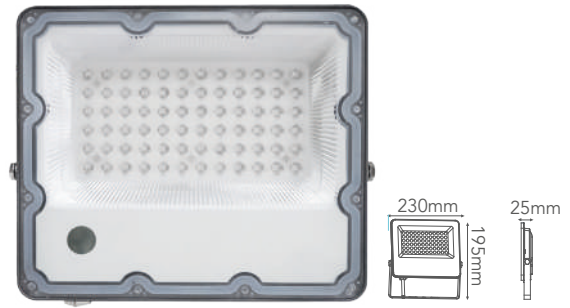

5-3650-RGB-*

-03 Gris

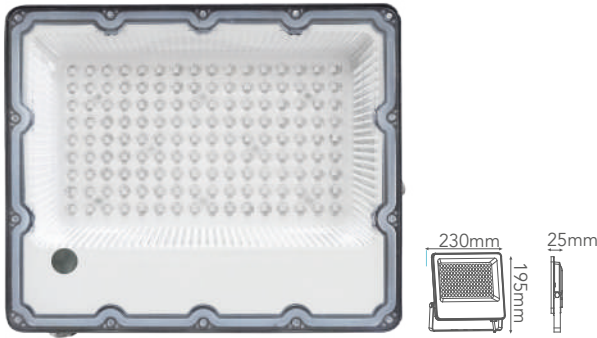

5-36100-RGB-*

-03 Gris

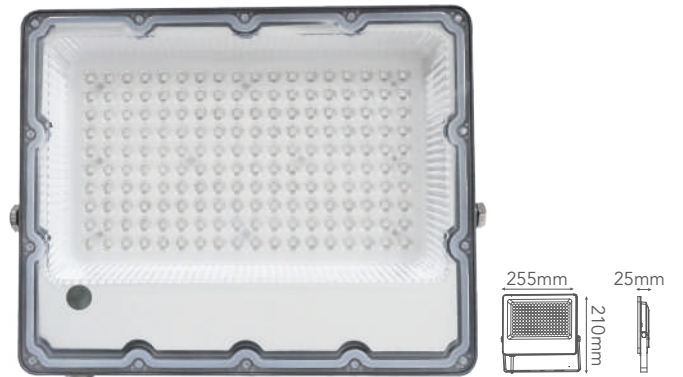

5-36150-RGB-*

-03 Gris



NOTA: Control remoto para cambios RGB, incluido.

Modelo	Watts	CT	LED	Lúmenes	Apertura	Voltaje	CRI	IP	Material
5-3620-RGB-*	20W	RGB	SMD	1600	120°	100-265V	>80	65	Aluminio
5-3650-RGB-*	50W	RGB	SMD	4000	120°	100-265V	>80	65	Aluminio
5-36100-RGB-*	100W	RGB	SMD	8000	120°	100-265V	>80	65	Aluminio
5-36150-RGB-*	150W	RGB	SMD	12000	120°	100-265V	>80	65	Aluminio

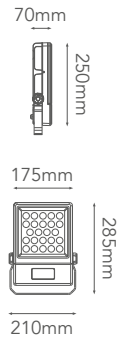

5-21101-RGB

-03 Gris

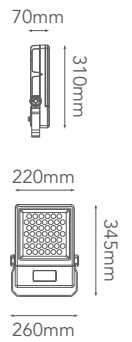

5-21201-RGB

-03 Gris



55-4021-RGBW

-04 Grafito



NOTA: Controlador se vende por separado.

Modelo	Watts	CT	LED	Apertura	Voltaje	CRI	IP	Material
5-21101-RGB	50W	RGB	SMD 3737	30°	100-240V AC	>80	65	Aluminio
5-21201-RGB	100W	RGB	SMD 3737	30°	100-240V AC	>80	65	Aluminio
55-4021-RGBW	15W	RGBW	SMD 2835		127V		65	Aluminio



INDUSTRIAL

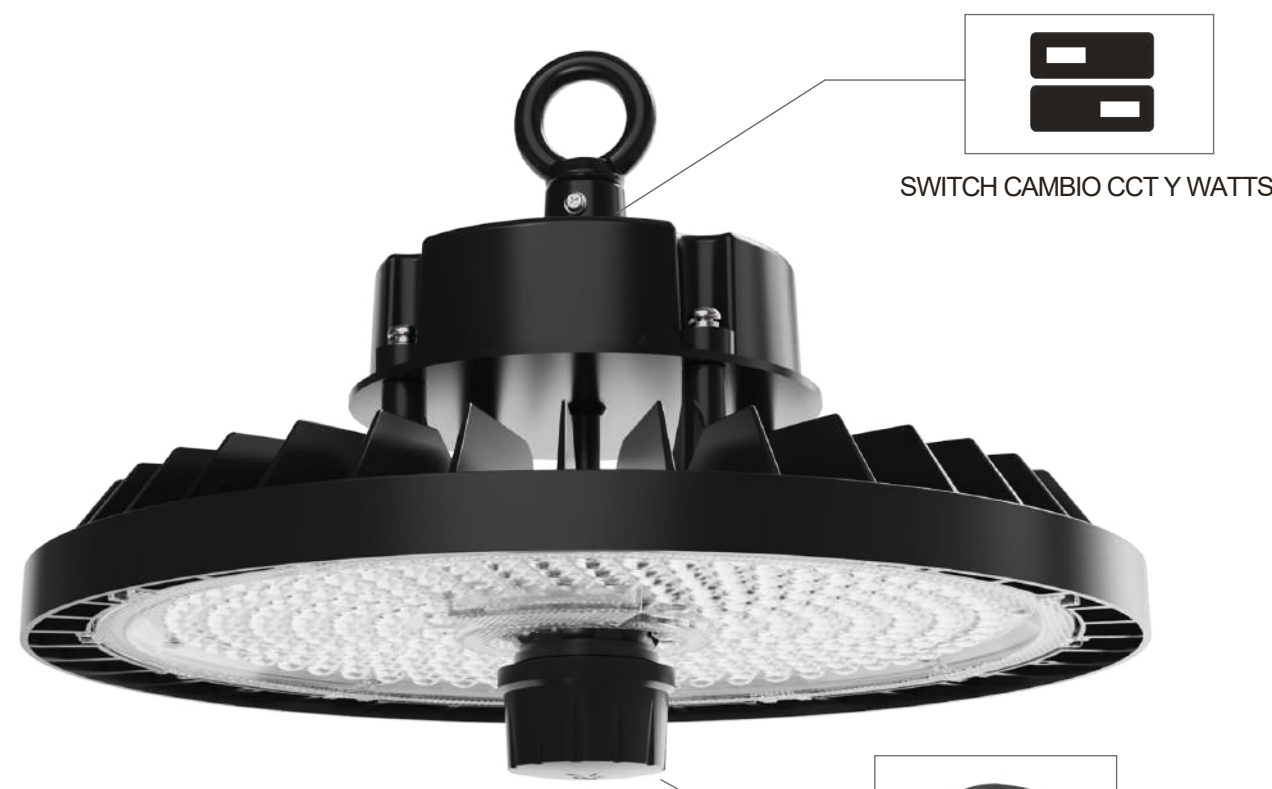

SWITCH CAMBIO CCT Y WATTS

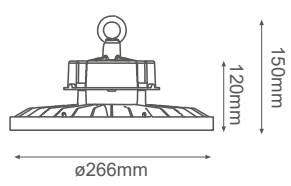

20-1150-3TC

-07 Negro



HD06VCRH 7B
SENSOR KIT



HD05R
CONTROL REMOTO

NOTA: Sensor kit y control se venden por separado.

Modelo	Switch Watts	Switch CT	LED	Lúmenes	Apertura	Voltaje	CRI	IP	Material
20-1150-3TC	80W/100W/150W	3000K/4000K/5000K	SMD2835	12000/15000/22500	90°	120-277V	>80	65	Aluminio + PC



20-3110-50

-07 Negro

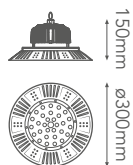

20-7100-50

-07 Negro

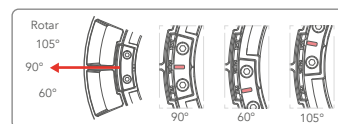
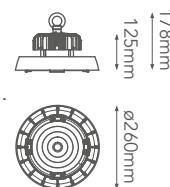

Lente ajustable patentado para lograr cambios de 60°, 90° y 105°



20-9080-40/65

-03 Gris

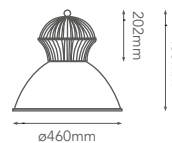

Modelo	Watts	CT	LED	Lúmenes	Apertura	Voltaje	CRI	IP	Material
20-3110-50	100W	5000K	SMD	10000	180°	110-240V	>80	65	Aluminio + PC
20-7100-50	100W	5000K	SMD	13000	60°, 90°, 105°	100-277V	>80	65	Aluminio + PC
20-9080-40/65	80W	4000K/ 6000K	7500	EPistar COB	90°	85-265V	>80	65	Aluminio

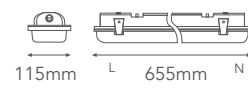

22-0210-*

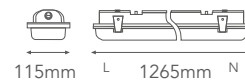

22-0218-*

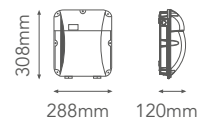

27-4001-40

*Fotocelda se vende por separado

Modelo	Watts	CT	Lúmenes	LED	Apertura	Voltaje	IP	Material
22-0210-*	20W	6000K	2000	SMD	180°	90-260V	65	Aluminio + PC
22-0218-*	36W	4000K / 6000K	3600	SMD	180°	90-260V	65	Aluminio + PC
27-4001-40	50W	4000K	4000	COB	120°	90-260V	65	Aluminio + PC



URBANA





15-0050-65

-03 Gris

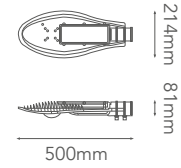

15-0100-65

-03 Gris

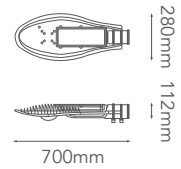

15-0150-65

-03 Gris

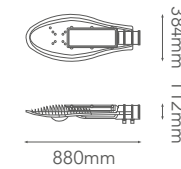

Modelo	Watts	CT	LED	Lúmenes	Apertura	Voltaje	IP	Material
15-0050-65	50W	6000K	COB bridgelux	4500	80°x140°	90-260V	66	Aluminio + Cristal Templado
15-0100-65	100W	6000K	COB bridgelux	9000	80°x140°	90-260V	66	Aluminio + Cristal Templado
15-0150-65	150W	6000K	COB bridgelux	13500	80°x140°	90-260V	66	Aluminio + Cristal Templado



SOLARES





Sensor de Movimiento



01-30605

-01 Blanco -07 Negro

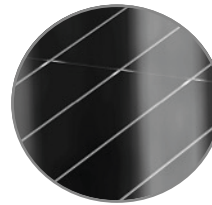
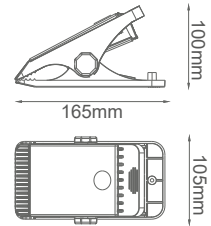

Potente panel solar
* Máxima utilización de la eficiencia de carga.
* Célula solar Mono grado A, alta conversión 21%+, también con carga alta en días nublados.
* Vidrio templado, fuerte y duradero.
* 10 años de vida útil.



Sensor de Movimiento



05-2016

-07 Negro

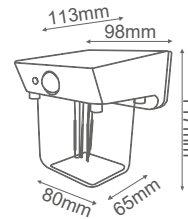

Modelo	Watts	CT	Lúmenes	LED	Apertura	Voltaje	CRI	IP	Material
01-30605-*	4W	4000K	400	SMD	-°	3.7V	80	44	ABS+ AS
05-2016-*	3W	4000K	190	SMD	-°	5.5V	80	54	PC

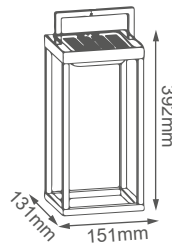

10-3341-*

-07 Negro

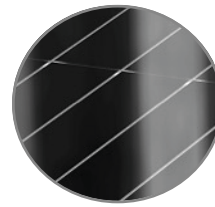

Potente panel solar
 * Máxima utilización de la eficiencia de carga.
 * Célula solar Mono grado A, alta conversión 21%+, también con carga alta en días nublados.
 * Vidrio templado, fuerte y duradero.
 * 10 años de vida útil.



03-2012 -*

-07 Negro

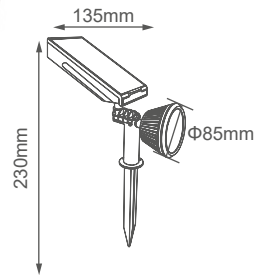

Modelo	Watts	CT	Lúmenes	LED	Apertura	Voltaje	CRI	IP	Material
10-3341-*	2W	3000K	231	-	89°	5V	80	54	Aluminio+Glas
03-2012-*	2W	3000K / 4000K	160	SMD	- °	5.5V	80	54	ABS + PC

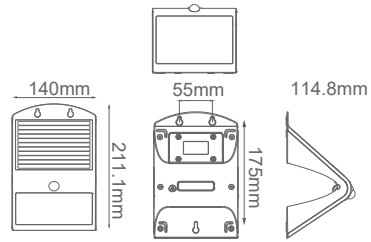

40-2104-*



- 01 Blanco
- 01 Blanco -07 Negro

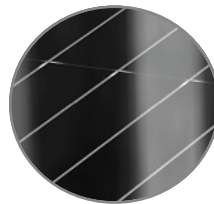

Potente panel solar
 * Máxima utilización de la eficiencia de carga.
 * Célula solar Mono grado A, alta conversión 21%+, también con carga alta en días nublados.
 * Vidrio templado, fuerte y duradero.
 * 10 años de vida útil.

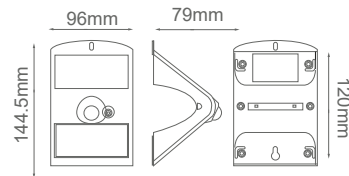

40-2115-*



- 01 Blanco
- 07 Negro



MULTIFUNCIONAL

Modelo	Watts	CT	Lúmenes	LED	Apertura	Voltaje	CRI	IP	Material
40-2104-*	4W	5000K	500	SMD	120°	4.5V	90	65	ABS + PC
40-2115-*	1.5W	5000K	220	SMD	90°	4.5V	90	65	ABS + PC

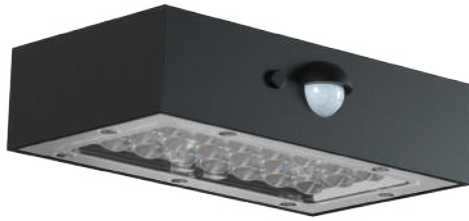

40-2303-*

-01 Blanco -07 Negro



Sensor de Movimiento

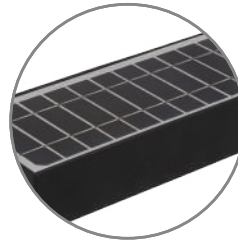
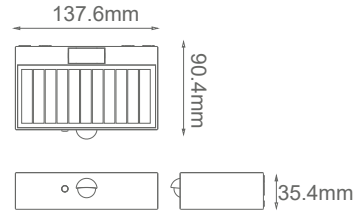

Potente panel solar
 * Máxima utilización de la eficiencia de carga.
 * Célula solar Mono grado A, alta conversión 21%+, también con carga alta en días nublados.
 * Vidrio templado, fuerte y duradero.
 * 20 años de vida útil.

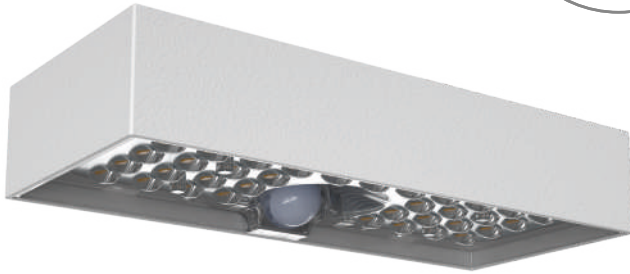

40-2306-*

-01 Blanco -07 Negro



Sensor de Movimiento

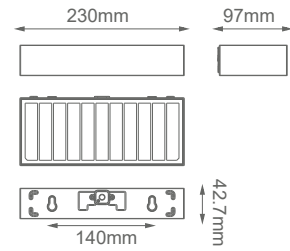

40-2015-*

-07 Negro



Sensor de Movimiento

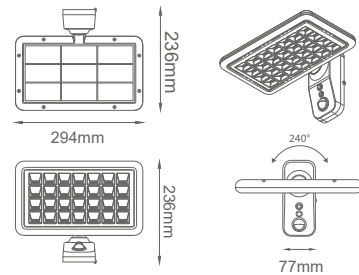

Modelo	Watts	CT	Lúmenes	LED	Apertura	Voltaje	CRI	IP	Material
40-2303-*	3W	4000K	350	SMD	140° * 70°	4.5V	90	65	ABS + PC
40-2306-*	6W	4000K	900	SMD	140° * 70°	4.5V	90	65	ABS + PC
40-2015-*	15W	3000K / 4000K	2000	SMD	85° - 95°	4.5V	90	65	ABS + PC



40-2608-*

-07 Negro



Sensor de Movimiento

- Diseño Inovador
- Multifuncional 7-1
- 1 Luminaria, 3 usos distintos
- Instalación libre de herramientas, plegable, súper flexible

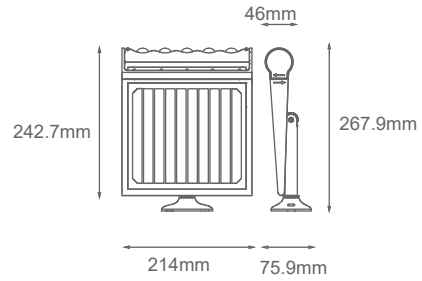

Una luminaria, 3 aplicaciones



Integrada.



Por separado



Luz de Emergencia



Modelo	Watts	CT	Lúmenes	LED	Tiempo de Carga	Duración Luz	Apertura	CRI	IP	Material
40-2608-*	8W	4000K	950	SMD	5-6 hrs de luz solar	Promedio 3 noches	120°	80	65	ABS + PC



- Con un diseño aerodinámico de forma redonda estereoscópica. Luce simple y elegante, lleno de modernidad. Su brillo y ángulo 360° hace que se aproveche al máximo la luz para una, Mejor iluminación.
- Debido a su óptica especializada la luz es uniforme, suave y eficiente.
- Esta luminaria solar de alto rendimiento, puede instalarse en muchos sitios distintos. ¡Su potencial es ilimitado!

CARACTERÍSTICAS

Diseño de iluminación único

- * Iluminación de 360°, combina perfectamente con su entorno.
- * La iluminación parece más suave y cómoda, sin reflejos.

Housing de alto Rendimiento

- * Carcasa ABS+PC, Anti-UV, V0 ignífugo.
- * Combinación clásica en blanco y negro, muy elegante.

Batería LiFePO4 de larga duración

- * Batería LiFePO4 de gran capacidad. 32700/6000 mAh/6,4 V/38,4 Wh.
- * Batería completamente nueva, no de segunda mano.
- * Protección contra sobrecarga y sobredescarga, segura y duradera.
- * Ciclos de carga 2000+, larga vida útil.
- * Reemplazable, los usuarios pueden reemplazarlo ellos mismos.
- * UN38.3, certificado MSDS.



Potente panel solar

- * Máxima utilización de la eficiencia de carga.
- * Célula solar Mono grado A, alta conversión 21%+, también con carga alta en días nublados.
- * Vidrio templado, fuerte y duradero.
- * 20 años de vida útil.

LED brillantes

- * LED SMD2835 marca Everlight.
- * Lente óptica lechosa, suave y antideslumbrante.
- * Brillo alto.
- * Certificado LM-80.

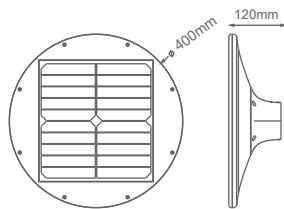

52-4020-*

-07 Negro



*Poste no incluido

Modelo	Watts	CT	Lúmenes	LED	Apertura	Voltaje	CRI	IP	Material
52-4020-07	20W	3000K / 4000K	2300	SMD	360°	4.5V	90	65	ABS + PC



Potente panel solar
 * Máxima utilización de la eficiencia de carga.
 * Célula solar Mono grado A, alta conversión 21%+, también con carga alta en días nublados.
 * Vidrio templado, fuerte y duradero.
 * 20 años de vida útil.

25-6215-07

-07 Negro

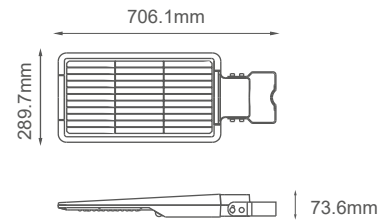

25-6240-07

-07 Negro



Larga Duración de Iluminación



Modelo	Watts	CT	Lúmenes	LED	Apertura	Voltaje	CRI	IP	Material
25-6215-07	15W	5000K	1600	SMD	60°	4.5V	90	65	ABS + PC
25-6240-07	40W	5000K	6000	SMD	60°	7.4V	90	65	ABS + PC



TIRAS LED



Bajo voltaje
Interiores



FB-43528-*

LED COB

Características

Lúmenes	Luz Cálida WW (3000K) / 990 lm/m Luz Neutra NW (4250K) / 1100 lm/m
Dimensiones	L5000 x W8 x H1.5mm
Consumo	55W (11W/m)
Corte ✂	4cm
Cantidad de LEDs	352 LEDs/m
Voltaje	24V CD
Corriente	3A (60mA por unidad)
Humedad Relativa	40%~70%
Temp. Ambiente	-20°~45°C
Protección	IP20



3000K



4250K

Accesorios

*Se venden por separado



Fuente de poder
a 24V



F2B-0208
Tira-Tira



F4B-2208
Tira-Cable-Tira



F3B-0218
Tira-Cable



AP-1616
Perfil 90°



AP-2507
Perfil arco



AP-2811
Perfil recto

COB

Bajo voltaje
Interiores



FB-72282-*
2835 Top LED (0.2)W

Características

Lúmenes	Luz Cálida WW (3000K) / 1080 lm/m Luz Neutra NW (4000K) / 1320 lm/m
Dimensiones	L5000 x W8 x H1.5mm
Unidad / Corte	6 LEDs / 10cm
Consumo	72W (14.4W/m)
Cantidad de LEDs	300 LEDs (60LEDs/m)
Voltaje	24V CD
Corriente	3A (60mA por unidad)
Humedad Relativa	40%~70%
Temp. Ambiente	-20°~45°C
Protección	IP20



FB-43282-*
2835 Top LED (0.2)W

Características

Lúmenes	Luz Cálida WW (3000K) / 684 lm/m Luz Neutra NW (4000K) / 792 lm/m
Dimensiones	L5000 x W8 x H1.5mm
Unidad / Corte	6 LEDs / 16.5cm
Consumo	43.2W (8.64W/m)
Cantidad de LEDs	180 LEDs (36LEDs/m)
Voltaje	24V CD
Corriente	1.8A (60mA por unidad)
Humedad Relativa	40%~70%
Temp. Ambiente	-20°~45°C
Protección	IP20



3000K



4000K



3000K



4000K

Accesorios

*Se venden por separado



Fuente de poder a 24V



FLS-2820
Conector Tira-Tira



AP-1616
Perfil 90°

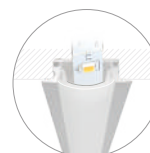

AP-2507
Perfil arco



AP-2811
Perfil recto

Bajo voltaje
Exteriores



FE-43287-*
2835 Top LED (0.2)W



FE-72287-*
2835 Top LED (0.2)W

Características

Lúmenes	Luz Cálida WW (3000K) / 684 lm/m Luz Neutra NW (4000K) / 792 lm/m
Dimensiones	L5000 x W10 x H4mm
Unidad / Corte	6 LEDs / 16.5cm
Consumo	43.2W (8.64W/m)
Cantidad de LEDs	180 LEDs (36LEDs/m)
Voltaje	24V CD
Corriente	1.8A (60mA por unidad)
Humedad Relativa	40%~70%
Temp. Ambiente	-20°~45°C
Protección	IP67

Características

Lúmenes	Luz Cálida WW (3000K) / 1320 lm/m Luz Neutra NW (4000K) / 1080 lm/m Luz Fría CW (6000K) / 1320 lm/m
Dimensiones	L5000 x W10 x H4mm
Unidad / Corte	6 LEDs / 10cm
Consumo	72W (14.4W/m)
Cantidad de LEDs	300 LEDs (60LEDs/m)
Voltaje	24V CD
Corriente	3A (60mA por unidad)
Humedad Relativa	40%~70%
Temp. Ambiente	-20°~45°C
Protección	IP67



3000K



4000K



3000K



4000K



6000K

Accesorios

*Se venden por separado



Fuente de poder a 24V



CP-51800
10 Fajos de fijación y 20 tornillos



WP-1000
Pegamento



F1-0110
Conector Tira-Cable



F2-0210
Conector Tira-Tira



AP-1616
Perfil 90°



AP-2507
Perfil arco



AP-2811
Perfil recto

MONOCROMÁTICAS

Bajo voltaje
Exteriores



FS-43285-*

2835 Top LED (0.2)W

Características

Lúmenes	Luz Cálida WW (3000K) / 684 lm/m Luz Neutra NW (4000K) / 792 lm/m
Dimensiones	L5000 x W8 x H2.5mm
Unidad / Corte ✂	6 LEDs / 16.5cm
Consumo	43.2W (8.64W/m)
Cantidad de LEDs	180 LEDs (36LEDs/m)
Voltaje	24V CD
Corriente	1.8A (60mA por unidad)
Humedad Relativa	40%~70%
Temp. Ambiente	-20°~45°C
Protección	IP54



3000K



4000K

Accesorios

*Se venden por separado



Fuente de poder
a 24V



FLS-1054-8MM
Conector
Tira-Cable-Tira



FLS-102B-2
Conector
Tira-Cable



FLS-102-C
Conector
Tira-Tira



FLS-102-FD2
Conector
Tira-Cable-Tira



AP-1616
Perfil 90°



AP-2507
Perfil arco



AP-2811
Perfil recto

Bajo voltaje
Exteriores



FS-48356-TC

2016 Top LED (0.2)W

Características

Lúmenes	576Lm/m @2500K 672Lm/m @6000K
Dimensiones	L5000 x W12 x H4mm
Unidad / Corte ✂	6 LEDs / 10cm
Consumo	48W (9.6W/m)
Cantidad de LEDs	600 LEDs (120LEDs/m)
Voltaje	24V CD
Corriente	2A (40mA por unidad)
Humedad Relativa	40%~70%
Temp. Ambiente	-20°~45°C
Protección	IP65



Temperatura de Color ajustable

Accesorios

*Se venden por separado



WP-1000
Pegamento
Se vende por separado



Fuente de poder a 24V



AP-1616
Perfil 90°



AP-2507
Perfil arco



AP-2811
Perfil recto



M2+RGB-33A
Controlador



WIFI-106
Receptor



F4-5A
Receptor

*Incluidos



Cable de conexión
incluido



CP-51800
10 Fajos de fijación
y 20 tornillos incluidos

CAMBIO DE TEMPERATURA DE COLOR

Bajo voltaje
Exteriores



FS-0036-RGB

5050 Top LED

Características

Lúmenes	RGB (Cambio de color)
Dimensiones	L5000 x W10 x H3mm
Unidad / Corte	6 LEDs / 16.5cm
Consumo	8.6W/m (43.2W/5m)
Cantidad de LEDs	180 LEDs (36LEDs/m)
Voltaje	24V CD
Corriente	2.4A (80mA por unidad)
Humedad Relativa	40%~70%
Temp. Ambiente	-20°~45°C
Protección	IP54



FS-9655-RGBW

RGBW Top LED

Características

Lúmenes	RGB + NW (4000K luz neutra) / 1008 lm/m
Dimensiones	L5000 x W12 x H3mm
Unidad / Corte	6LEDs / 10cm
Consumo	96W (19.2 W/m)
Cantidad de LEDs	300 LEDs (60LEDs/m)
Voltaje	24V CD
Corriente	4A (80mA por unidad)
Humedad Relativa	40%~70%
Temp. Ambiente	-20°~45°C
Protección	IP54



RGB



RGBW

Accesorios

*Se venden por separado



Fuente de poder a 24V



AP-1616 Perfil 90°



AP-2507 Perfil arco



AP-2811 Perfil recto



M8+M4-5A Controlador



WIFI-106 Receptor



F4-5A Receptor



CP-51800 10 Fajos de fijación y 20 tornillos

FS-0036-RGB

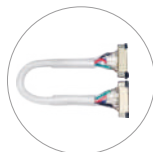

FLS-103-D Conector Tira-Cable-Tira

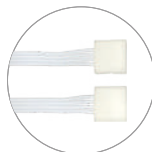

FLS-1054-10RGB Conector Tira-Cable-Tira



FLS-2854-10RGB Conector Tira-Tira

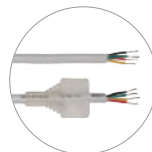

TR-1014 Conector Tira-Cable-Tira



M6+RGB-33A Controlador



FC-43286*

2835 Top LED (0.2)W



Características

Lúmenes	Luz Cálida WW (3000K) / 544 lm/m Luz Neutra NW (4000K) / 544 lm/m
Dimensiones	L5000 x W10 x H4.5mm
Unidad / Corte	6 LEDs / 16.5cm
Consumo	43.2W (8.64W/m)
Cantidad de LEDs	180 LEDs (36LEDs/m)
Voltaje	24V CD
Corriente	1.8A (60mA por unidad)
Humedad Relativa	40%~70%
Temp. Ambiente	-20°~45°C
Protección	IP68



FS-1036-RGB

5050 Top LED



Características

Lúmenes	RGB (Cambio de color)
Dimensiones	L5000 x W12 x H4.5mm
Unidad / Corte	6 LEDs / 16.5cm
Consumo	43.2W (8.64W/m)
Cantidad de LEDs	300 LEDs (60LEDs/m)
Voltaje	24V CD
Corriente	2.4A (80mA por unidad)
Humedad Relativa	40%~70%
Temp. Ambiente	-20°~45°C
Protección	IP68



3000K



4000K



RGB

Accesorios

Incluidos



CP-51800
10 Fajos de fijación
y 20 tornillos



2 mangas
termoretráctiles



Conector
inicial

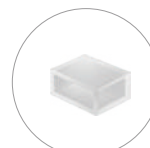

Tapa final

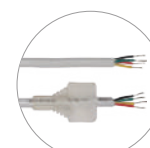

TR-1014
Conector
Tira-Cable-Tira

*Se venden por separado



Fuente de poder
a 24V



WP-1000
Pegamento



AP-2507
Perfil arco
No apto para
FS-1036-RGB



AP-1616
Perfil 90°



AP-2811
Perfil recto



FV-48110-*

2835 Top LED

Características

Lúmenes	Luz Cálida WW (3000K) / 615 lm/m Luz Neutra NW (4000K) / 615 lm/m
Dimensiones	W11xH7mm, Rollo con L50m
Unidad / Corte	30 LEDs / 50cm
Consumo	480W (9.6W/m)
Cantidad de LEDs	60 LEDs/m
Voltaje	110V AC
Corriente	1.8A (60mA por unidad)
Humedad Relativa	40%~70%
Temp. Ambiente	-20°~45°C
Protección	IP65

Se vende por metro o al comprar rollo, incluye kit de instalación: SET-48110



3000K



4000K



FS-27352-*

3528 Top LED

Características

Lúmenes	Luz Cálida WW (3000K) / 615 lm/m Luz Fría CW (6000K) / 230 lm/m
Dimensiones	W110xH75mm, Rollo con L50m
Unidad / Corte	6 LEDs / 50cm
Consumo	180W (3.6W/m)
Cantidad de LEDs	60 LEDs (36LEDs/m)
Voltaje	110V AC
Corriente	1.8A (60mA por unidad)
Humedad Relativa	40%~70%
Temp. Ambiente	-20°~45°C
Protección	IP44

Se vende por metro o al comprar rollo, incluye kit de instalación: SET-48110



6000K

Accesorios

*Se venden por separado



SET-48110
Kit de instalación

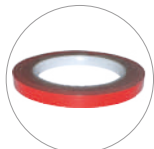

AT-2011
Cinta doble cara



CP-27352
Clip de sujeción



EC-27352
Tapa final



WP-1000
Pegamento



AP-1616
Perfil 90°



AP-2811
Perfil recto

Materiales:

1. Perfil de aluminio 6063 con aleación de óxido en la superficie.
2. Difusor de PC opalino.
3. Tapa de plástico.
4. Grapa de plástico o acero inoxidable.
5. Accesorios incluidos. También se venden por separado.

AP-1616

-12 Aluminio

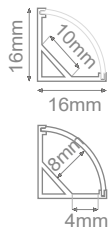

*Longitud: 2m

Accesorios



TAP-1616
Par de tapas
finales



CLIP-1616
Par de grapas
y tornillos

AP-2507

-07 Negro -12 Aluminio

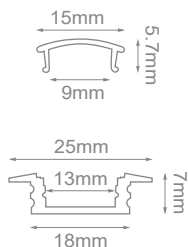

*Longitud: 2m



TAP-2507
Par de tapas
finales



CLIP-2507
Par de grapas
y tornillos

AP-2011

-07 Negro -12 Aluminio

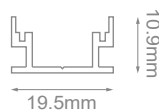

*Longitud: 2m

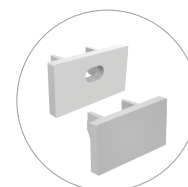

Par de tapas
finales

AP-2811

-12 Aluminio

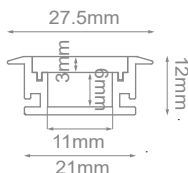

*Longitud: 2m



TAP-2811
Par de tapas
finales



FS-27140

Características

Lúmenes	600-800 lm
Dimensiones	L50m x W10mm X 6mm
Unidad / Corte	25 cm
Consumo	450W (9W/m)
Cantidad de LEDs	N/A
Voltaje	110V
Humedad Relativa	40%~70%
Temp. Ambiente	-20°~45°C
Protección	IP67

COLOR

-CW 6500K
-NW 4000K
-WW 3000K
-BL AZUL
-RD ROJO
-GR VERDE
-NO ROSA
-YE AMARILLO ORO
-JB AZUL HIELO
-PR PÚRPURA

*PRESENTACIÓN CARRETE 50m
*NEON

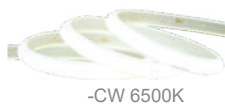

-CW 6500K



-NW 4000K



-WW 3000K



-BL AZUL



-RD ROJO



-GR VERDE



-NO ROSA



-YE AMARILLO ORO

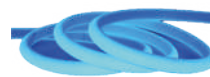

-JB AZUL HIELO



-PR PÚRPURA

Accesorios



SET-27140
Set de conexión



EC-27140
Clip de montaje



CP-27140
Tapa final

*Se venden por separado

CONECTORES PARA EXTERIOR. Estos conectores le ayudarán a que sus instalaciones en exterior sean más profesionales y durables.



LCH-1312-68-3P

CONECTOR DE TIPO LINEAR



LCH-1312-68-4P

CONECTOR DE TIPO LINEAR



LCH-1165-68-T3PA

CONECTORES DE TIPO LINEAR



LCH-1165-68-T5P

CONECTORES DE TIPO LINEAR - 5 Polos



Fuente de poder	PS-12025
Poder de carga	25W
Voltaje de entrada	90-137 VCA
Voltaje de salida	12V CD
Temp. de operación	-20°~60°C / 20%~90%
Dimensiones	L85 x W58 x H38mm
Protección	IP20 Uso interior



Fuente de poder	PS-12050	PS-24050
Poder de carga	50W	
Voltaje de entrada	90-137 V CA	
Voltaje de salida	12V CD	24V CD
Temp. de operación	-20°~60°C / 20%~90%	
Dimensiones	L110 x W78 x H35mm	
Protección	IP20 Uso interior	



Fuente de poder	PS-12100	PS-24100
Poder de carga	100W	
Voltaje de entrada	90-137 V CA	
Voltaje de salida	12V CD	24V CD
Temp. de operación	-20°~60°C / 20%~90%	
Dimensiones	L159 x W97 x H38mm	
Protección	IP20 Uso interior	



Fuente de poder	PS-12150	PS-24150
Poder de carga	150W	
Voltaje de entrada	90-137 V CA	
Voltaje de salida	12V CD	24V CD
Temp. de operación	-20°~60°C / 20%~90%	
Dimensiones	L199 x W98 x H42mm	
Protección	IP20 Uso interior	



Fuente de poder	PS-12250	PS-24250
Poder de carga	250W	
Voltaje de entrada	90-137 V CA (Cambia con Switch)	
Voltaje de salida	12V CD	24V CD
Temp. de operación	-20°~60°C / 20%~90%	
Dimensiones	L200 x W110 x H50mm	
Protección	IP20 Uso interior	



Fuente de poder	PS-24400
Poder de carga	400W
Voltaje de entrada	90-137 VCA
Voltaje de salida	24V CD
Temp. de operación	-20°~60°C / 20%~90%
Dimensiones	L215 x W115 x H50mm
Protección	IP20 Uso interior

Dimeables



Fuente de poder	PS-12100-D	PS-24100-D
Poder de carga	100W	
Voltaje de entrada	127V	
Voltaje de salida	12V / 6.6A	24V
Temp. de operación	-20°~60°C / 20%~90%	
Dimensiones	L148 x W48 x H25mm	
Protección	IP20 Uso interior	



Fuente de poder	PS-12150-D	PS-24150-D
Poder de carga	150W	
Voltaje de entrada	127V	
Voltaje de salida	12V / 12.5A	24V
Temp. de operación	-20°~60°C / 20%~90%	
Dimensiones	L210 x W48 x H25mm	
Protección	IP20 Uso interior	



Fuente de poder	PS-12250-D	PS-24250-D
Poder de carga	250W	
Voltaje de entrada	127V	
Voltaje de salida	12V / 20.8A	24V
Temp. de operación	-20°~60°C / 20%~90%	
Dimensiones	L210 x W48 x H25mm	
Protección	IP20 Uso interior	

FUENTES DE PODER



Transformador	TRA-1245
Poder de carga	Máx. 45W
Voltaje de entrada	90~137V CA
Voltaje de salida	12V CD
Temp. de operación	-20°~60°C / 20%~90%
Protección	IP67
Dimensiones	L160 x W52 x H32mm



Transformador	TRA-2430
Poder de carga	30W
Voltaje de entrada	90~137V CA
Voltaje de salida	24V CD / 2.5A
Frecuencia	47~63Hz
Temp. de operación	-20°~60°C / 20%~90% HR
Protección	IP67
Dimensiones	L222 x W30 x H20mm



Transformador	TRA-2460
Poder de carga	Máx. 60W
Voltaje de entrada	90~137V CA
Voltaje de salida	24V CD
Frecuencia	47~63Hz
Temp. de operación	-20°~60°C / 20%~90% HR
Protección	IP67
Dimensiones	L175 x W72 x H45mm



Transformador	TRA-1250
Poder de carga	Máx. 50W
Voltaje de entrada	127V CA
Voltaje de salida	12V CA para foco MR16
Protección	IP65



Transformador	TRA-12100	TRA-24100
Poder de carga	100W	
Voltaje de entrada	90~137V CA	
Voltaje de salida	12V CD / 8.5A	24V CD / 4.2A
Frecuencia	47~63Hz	
Temp. de operación	-20°~60°C / 20%~90% HR	
Protección	IP67	
Dimensiones	L207 x W66 x H44mm	



Transformador	TRA-12200	TRA-24200
Poder de carga	200W	
Voltaje de entrada	90~137V CA	
Voltaje de salida	12V CD / 16.5A	24V CD / 8.3A
Frecuencia	47~63Hz	
Temp. de operación	-10°~60°C / 20%~90% HR	
Protección	IP67	
Dimensiones	L 225 x W120 x H55mm	



astro

— UTECH —

LED - Controller

Líderes en control LED

2024

www.astroled.com.mx

EX

Paneles Touch
100-240V AC

Control de 1 Zona

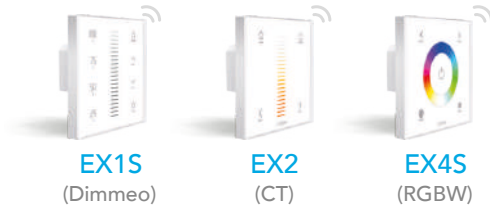

Control de Multizona

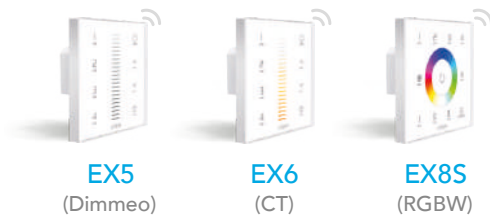

EXC

Paneles Touch
100-240V AC

Control de Atenuación



WiFi-106

Control por red WiFi
12~24VDC



----- Conexión inalámbrica
———— Cableado

*RF: Radio Frecuencia 2.4 GHZ

Receptores L-BUS®



F4-5A



F4-CC

Especificaciones

Modelo	F4-5A	F4-CC
Nombre	CV LED driver inalámbrico	CC LED driver inalámbrico
Señal inalámbrica	RF 2.4GHz	
Señal inalámbrica	5~24V DC	18~48V DC
Voltaje de salida	5~24V DC	3~46V DC
Corriente de entrada	5A x 4CH Máx. 20A	CC 350/700/1050mA x 4 CH
Corriente de salida	(0~25W...120W) x 4CH Máx. 480W	(1.05W~48.3W) x 4CH Máx. 193.2W
Protección	Sobrecorriente / sobrecalentamiento / cortocircuito / circuito abierto / conexión de protección inversa, se recupera automáticamente. IP20	
Temp. de Operación:	-30°C ~ 55°C	
Dimensiones	L175xW44xH30mm	

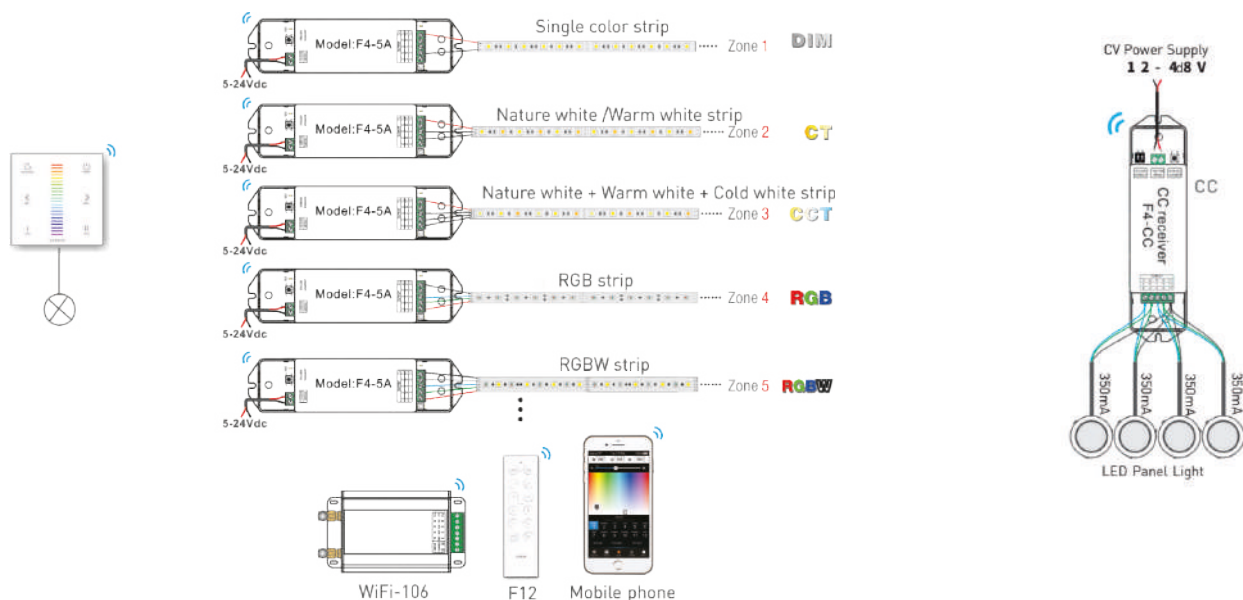

Paneles Touch L-BUS®

EX

Control de 1 zona

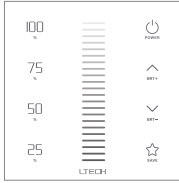

EX1S
(Dimmeo)



EX2
(CT)



EX4S
(RGBW)

Control de Multizona

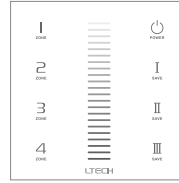

EX5
(Dimmeo)



EX6
(CT)



EX8S
(RGBW)

Especificaciones

Modelo	EX1S	EX2	EX4S	EX5	EX6	EX8S
Control	Dimmeo	CT	RGBW	Dimmeo	CT	RGBW
Zonas	1 zona			4 zonas		
Voltaje de entrada	100-240V AC					
Señal de salida	RF 2.4GHz, DMX512					
Temp. de operación	-20°C~55°C					
Dimensiones	L86×W86×H36(mm)					

EXC

Control de Atenuación

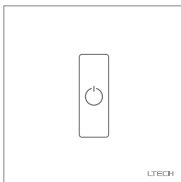

EXC1

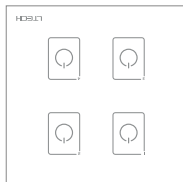

EXC2

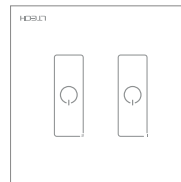

EXC3

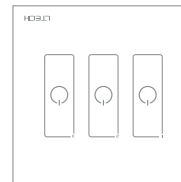

EXC4

Especificaciones

Modelo	EXC1	EXC2	EXC3	EXC4
Canales	1	2	3	4
Voltaje de entrada	100-240V AC			
Señal de salida	RF 2.4GHz, DMX512			
Temp. de operación	-20°C~55°C			
Dimensiones	L113×W112×H50(mm)			

WiFi-106 L-BUS®

Control por red WiFi



WiFi-106

- » Señal inalámbrica: 2.4GHz WiFi, Protocolo 802.11b/g/n
- » Voltaje de entrada: 12~24VCD
- » Corriente de Salida: 4Ax4CH Máx.16A
- » Máx. Poder de Salida: (0~48W...96W) x 4CH Max:348W
- » Control de Salida: CT, Atenuación, RGB, RGBW
- » Temp. de operación: -30°~55°C
- » Dimensiones: L128xW73xH45(mm)

Control Remoto - F12

- » Voltaje de Operación: 3VCD (Batería CR2032)
- » Frecuencia Wireless: RF 2.4GHz

Repetidores L-BUS®

Inalámbricos



EBOX-AP

- » Señal inalámbrica: RF 2.4GHz
- » Voltaje de entrada: 5-24V DC
- » Alcance: 30m
- » Corriente: Máx. 1.2A
- » Temp. de operación: -30°C~55°C
- » Dimensiones: L55xW55xH21(mm)



EBOX-TD

- » Señal inalámbrica: RF 2.4GHz
- » Voltaje de entrada: 100~240V AC
- » Dimeo: ELV
- » Corriente: Máx. 1.2A
- » Poder: LEDs Dimeables: Máx. 150W
- » Temp. de operación:
- » Dimensiones:

Repetidores L-BUS®



REP-3063 Sumergible RGB y Dimers de bajo voltaje CC y CV

- » Voltaje de entrada 5~24V DC
- » Corriente de entrada 3A x 3CH Máx. 9A
- » Corriente de salida Máx. 45W/108W/216W (5V/12V/24V)
- » Poder de salida 108W a 12V, 216W a 24V
- » Protección IP68
- » Temp. de operación: -30°C ~ +65°C
- » Dimensiones L181xW35xH28mm



REP-3060 RGB y Dimers de bajo voltaje CC y CV

- » Señal de entrada PWM (200Hz-2000Hz)
- » Voltaje de entrada 5~24V DC
- » Corriente de entrada 5A x 3CH Máx. 15A
- » Poder de salida (0~25W...120W) x 3CH Máx. 360W
- » Protección IP20
- » Temp. de operación: -30°C ~ 55°C
- » Dimensiones L121xW39xH39mm



REP-3070 RGB y Dimers de bajo voltaje CC y CV

- » Señal de entrada PWM
- » Voltaje de entrada 12~48V DC
- » Corriente de entrada 8A x 3CH Máx. 24A
- » Poder de salida 288W / 576W / 864W / 1152W (12V / 24V / 36V / 48V)
- » Temp. de operación: -30°C ~ 65°C
- » Dimensiones L148xW87xH31mm



REP-3040-5A RGB y Dimers de bajo voltaje CC y CV

- » Señal de entrada PWM (200Hz-2000Hz)
- » Voltaje de entrada 5~24V DC
- » Corriente de entrada 5A x 4CH Máx. 20A
- » Poder de salida (0~25W...120W) x 3CH Máx. 480W
- » Temp. de operación: -30°C ~ 55°C
- » Dimensiones L178xW48xH33mm

K1/K2 Switch Paneles Touch

Serie de panel inteligente touch



Switch On/Off de rápida respuesta.

Encienda o apague la luz de cualquier habitación con tan solo



K1



K2

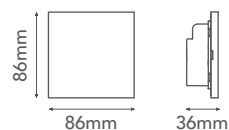

Especificaciones

Modelo	K1	K2
Voltaje de entrada	220V AC, 50Hz	
Tipo de carga	Lámparas incandescente, fluorescentes y LED	
Poder de carga	Máx. 200WxCH MÍN. 5WxCH	
Temp. de operación	-20°C~55°C	
Dimensiones	L86xW36xH86mm	



Caja de fijación CR-D1
*Se vende por separado

Mini RF Wireless



3 controles remotos distintos,
1 receptor



Controladores M3-3A

» Voltaje de entrada	DC12V-DC24V
» Corriente de Carga	Máx. 3A x 3CH
» Máx. Poder de Salida	108W/216W (12V/24V)
» Temp. de operación	-30°~55°C
» Dimensiones	L135xW30xH20mm

Mini Controles en Kit

Incluyen Control Remoto + Controlador.



M1+RGB-33A

CR Dimeo



M2+RGB-33A

CR Temp. de color



M6+RGB-33A

Cambio de Color



Mini para RGBW M8+M4-5A

D series Panel Touch

Bajo Voltaje



DIM-D1

- » Voltaje de entrada DC12V~DC24V
- » Máx. corriente de carga 4A x 3CH Máx. 12A
- » Máx. poder salida 144W/288W (12V/24V)
- » Nivel escala grises 4096
- » Temp. de Operación -20° ~ 60°C
- » Dimensiones L86xW86xH36mm



Caja de fijación CR-D1
**Se vende por separado*



Diagrama de Cableado

Ejemplo de Cableado 1: Conexión con tira 12V, Máx. 144W(12V)



Ejemplo de Cableado 2: Conexión con tira 24V, Máx. 288W(24V)



Astro LED Lighting

GARANTÍA LIMITADA

Esta garantía está limitada a lo antes mencionado y esta, y cualquier otra garantía implícita por las leyes estatales se aplicará solamente por el periodo de 3 años.

OV Iluminación, S.A. de C.V. no será responsable por ninguna pérdida o cualquier daño accidental o consiente de cualquier clase, ya sea basado en la garantía, contrato o negligencia y de alguna manera concertado con la venta, uso o reparación de este producto. A menos que haya alguna modificación a la ley, la máxima responsabilidad de OV Iluminación, S.A. de C.V., no deberá exceder en ningún caso el precio del producto reclamado como defectuoso.

Por un período de 3 años a partir de la fecha de compra OV Iluminación, S.A. de C.V. garantiza el producto marca Astro LED Lighting de cualquier defecto en cuanto a materiales utilizados y a la elaboración. En caso de alguna falla contemplada dentro de la garantía, OV Iluminación, S.A. de C.V. reparará la unidad o proveerá un repuesto para la unidad y componentes del mismo sin costo adicional para el cliente. Si después de ser probado y examinado se comprueba que el producto no está dentro de las condiciones de garantía, todos los costos de instalación, traslado o reinstalación serán responsabilidad del comprador.

ESTA GARANTÍA LE BRINDA DERECHOS LEGALES ESPECÍFICOS Y USTED PODRÍA TENER OTROS DERECHOS QUE VARÍAN DE ESTADO A ESTADO.

LIMITACIONES Y EXCLUSIONES

Por reclamo de garantía, el comprador debe regresar el producto pagando por adelantado el servicio de traslado a las instalaciones de OV Iluminación, S.A. de C.V. ubicada en Prolongación AV. el Coli int 14, 45069, Zapopan, Jalisco, dentro de los siguientes 30 días de la fecha de la elaboración de la factura. Si nuestras pruebas y exámenes demuestran que están dentro de la garantía se expedirá una nota de crédito. Esta garantía es válida solo para el comprador original de la unidad y no para algún comprador posterior. Esta garantía no cubre defectos, mal funcionamiento, o fallas causadas por reparaciones hechas mientras esté la unidad en poder del comprador, por falta de mantenimiento necesario o por mal uso del producto.

2024

+10 años dedicados
a la iluminación arquitectónica

Comprometidos a ofrecer productos lumínicos de vanguardia que ayuden
a transformar espacios en ambientes de bienestar y confort.

astro
LED Lighting

www.astroled.com.mx

 Facebook: [astroledlighting](https://www.facebook.com/astroledlighting)

 Instagram: [astroledlighting](https://www.instagram.com/astroledlighting)